

**Appendix A:**  
**Noise Assessment Report**



Windlectric Inc.

## Noise Assessment Report

For

Amherst Island Wind Project

H340642-0000-07-124-0002

Rev. 8

July 14, 2014

Windlectric Inc.

## Noise Assessment Report

For

Amherst Island Wind Project

H340642-0000-07-124-0002

Rev. 8

July 14, 2014

Project Report

July 14, 2014

**Windlectric Inc.**  
**Amherst Island Wind Project**

**Noise Assessment Report**

Hatch

Prepared by:



Oleg Belashov, M.A.Sc., P.Eng.  
e-mail: [obelashov@hatch.ca](mailto:obelashov@hatch.ca)  
Tel: 905-374-0701 x 5269

July 14, 2014

Date

Approved by:

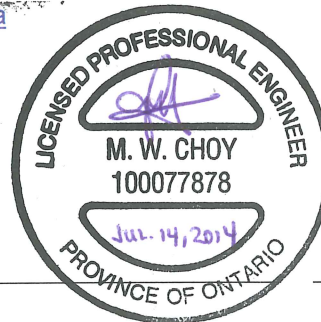

Mervyn Choy, P.Eng.  
e-mail: [mchoy@hatch.ca](mailto:mchoy@hatch.ca)  
Tel: 905-403-4200, Ext 3562

July 14, 2014

Date

Windlectric Inc.

Approved by:

Sean Fairfield  
e-mail: [Sean.Fairfield@algonquinpower.com](mailto:Sean.Fairfield@algonquinpower.com)

July 14, 2014

Date

## Table of Contents

<b>1. Introduction</b>	<b>1</b>
<b>2. Project General Description</b>	<b>2</b>
2.1 Site Location	2
2.2 Acoustical Environment	2
2.3 Approach to the Study	2
<b>3. Noise Sources</b>	<b>4</b>
3.1 Substation Transformer	4
3.2 Unit Transformers	4
3.3 Wind Turbine Generators	4
3.3.1 Adjustment to Wind Turbine Generator Acoustic Emissions for Wind Speed Profile	5
3.4 Adjacent Wind Farms	5
<b>4. Noise Receptors and Points of Reception</b>	<b>6</b>
<b>5. Mitigation Measures</b>	<b>7</b>
<b>6. Noise Impact Assessment</b>	<b>8</b>
6.1 Compliance with Performance Limits	8
<b>7. Conclusions and Recommendations</b>	<b>9</b>
<b>8. References</b>	<b>10</b>
<b>Appendix A</b>	<b>Geographic Location of Project Study Area, Wind Farm Layout, Land Use Schedule</b>
<b>Appendix B</b>	<b>Noise Sources</b>
<b>Appendix C</b>	<b>Sound Pressure Levels for Points of Reception, Noise Maps from CADNA-A</b>
<b>Appendix D</b>	<b>CADNA-A Calculations and Verification</b>

## List of Tables

Table 3.1	Basic Characteristics of Siemens SWT-2.3-113 and SWT-2.221-113 WTG Models....	5
Table 6.1	Sound Pressure Limits for Class 3 Areas .....	8

## List of Figures

Figure 2.1	CADNA-A Configurations.....	3
------------	-----------------------------	---

**Noise Assessment Report Revision Summary**

Revision #	Summary
5	<p>The Noise Assessment Report dated March 22, 2013 (Revision 4) has been revised to address MOE comments submitted by Kristina Rudzki. The following changes were made:</p> <ul style="list-style-type: none"> <li>• Table B.5 Wind Turbine Generator Sound Power Level Adjustment was added in Appendix B.</li> </ul>
6	<p>The Noise Assessment Report dated September 5, 2013 (Revision 5) has been revised to address MOE comments submitted by Mahdi Zangeneh. The following changes were made:</p> <ul style="list-style-type: none"> <li>• Figure A.1 was modified to provide a better view of the receptor congested areas where receptor IDs were obscured. The figure size was increased to A0.</li> <li>• Sound power values in Table B.5 were converted from dBA to dB units.</li> <li>• Figure C.3 showing noise contours and WTG proximity at noise receptor R557 was added.</li> </ul>
7	<p>The Noise Assessment Report dated June 2, 2014 (Revision 6) has been revised to address the addition of a “hunting shack/bunkie” as an existing receptor with the ID R727. The following changes were made:</p> <ul style="list-style-type: none"> <li>• Updated Table B.1 to reflect change of WTG model for S07, S18, S26 from SWT-2.3-113 to the SWT 2.221-113</li> <li>• Table C.1 updated to reflect addition of existing non-participant receptor R727 and change of WTG model for S07, S18, and S26.</li> <li>• Table C.2 updated to reflect change of WTG model for S07, S18, and S26</li> <li>• Figures A.1, and A.2 updated to include receptor R727</li> <li>• Figures C.1, C.2, and C.3 were updated to include receptor R727 and reflect the noise contours based on change of WTG model for S07, S18, and S26</li> <li>• Appendix B – Updated Contract Acoustic Emissions documents and added additional documents detailed below as provided by Siemens: <ul style="list-style-type: none"> <li>◆ Summary SWT-2.3-113 Rev 1 P6.024.13 Test Report Summary</li> <li>◆ Amherst Island MOE Acoustic Letter from Siemens</li> </ul> </li> </ul>
8	Administrative changes only.

**REPORT DISCLAIMER**

This report has been prepared by Hatch for the sole and exclusive use of Windlectric Inc. (Proponent), for the purpose of assisting the management of the Client in making decisions with respect to the potential development of the Amherst Island Wind Project, and for attachment to their application for a Renewable Energy Approval from the Ontario Ministry of the Environment (MOE) and shall not be (a) used for any other purpose, or (b) provided to, relied upon or used by any third party.

This report contains opinions, conclusions and recommendations made by Hatch, using its professional judgment and reasonable care. Use of or reliance upon this report by Client is subject to the following conditions:

- (a) the report being read in the context of and subject to the terms of the agreement between Hatch and the Client dated January 20, 2012 (the "Agreement"), including any methodologies, procedures, techniques, assumptions and other relevant terms or conditions that were specified or agreed therein;
- (b) the report being read as a whole, with sections or parts hereof read or relied upon in context;
- (c) the conditions of the site may change over time or may have already changed due to natural forces or human intervention, and Hatch takes no responsibility for the impact that such changes may have on the accuracy or validity of the observations, conclusions and recommendations set out in this report; and

the report is based on information made available to Hatch by the Client or by certain third parties (Siemens, Land Information Ontario, First Base Solutions), including publicly available information; and unless stated otherwise in the Agreement, Hatch has not verified the accuracy, completeness or validity of such information, makes no representation regarding its accuracy and hereby disclaims any liability in connection therewith.



## 1. Introduction

This report presents the results of the noise assessment study required for Wind Farms under Ontario Regulation 359/09 [1] and its amendment Ontario Regulation 521/10 [2], as part of the Renewable Energy Approval (“REA”) Process.

Windlectric Inc. (hereinafter referred to as the “Proponent”) is proposing to develop the Amherst Island Wind Project, a 75-MW wind energy project (the “Project”). The Project will be located on Amherst Island, within Loyalist Township in the County of Lennox and Addington, Ontario about 11 km southwest of Kingston.

A total of 37 sound sources were included in this study. Twenty one (21) Siemens SWT-2.3-113, fifteen (15) SWT-2.221-113 wind turbine generators (WTGs), and one 34.5-kV/115-kV/85-MVA substation transformer were evaluated for noise compliance, in an area extending approximately 14 km by 5 km. It should be emphasized that the Project capacity of 81.6 MW evaluated for noise impact will be reduced to 75 MW and only thirty three (33) wind turbine generators will be installed. Removal of three (3) WTGs will further reduce the overall noise impact from the Project.

The report was prepared according to the publication entitled “Noise Guidelines for Wind Farms” [3] by the Ministry of the Environment (2008) and includes a general description of the Project, noise sources, noise receptors, assessment of compliance, and all supporting information relevant to the Project.

## 2. Project General Description

It is intended to permit 36 locations for twenty one (21) Siemens SWT-2.3-113 and fifteen (15) SWT-2.221-113 wind turbine generators for a total capacity of 81.6 MW, and one for a 34.5-kV/115-kV/85-MVA substation transformer. However, as mentioned before only 33 WTGs will be eventually installed for a total Project capacity of 75 MW. Basic characteristics of the proposed WTG models are available in Table 3.1.

The 34.5-kV power from the WTGs will be transmitted to the substation where it will be stepped up to 115 kV by a 34.5-kV/115-kV/85-MVA transformer.

The Project is considered to be a Class 4 Wind Facility, according to the classification presented in Ontario Regulation 359/09.

### 2.1 Site Location

The Project will be located on Amherst Island, within Loyalist Township in the County of Lennox and Addington, Ontario. The Project Area, extending 14 km by 5 km, is situated about 11 km southwest of Kingston on land, most of which is zoned as prime agricultural, and the rest as rural. Figure A.1 in Appendix A shows the geographical location of the Project along with topographical features. The detailed Land Use Schedule obtained from Loyalist Township, is available in Figure A.2 of Appendix A.

### 2.2 Acoustical Environment

The Project WTGs will be situated on private land on the island. There are no major industrial facilities on the island; however a number of large manufacturing facilities, such as Lafarge cement plant and Lennox generating station, are located on the mainland along the shore opposite to the Project Area. Noise emitted by these facilities can be heard along the island north shore during day and night time. The Frontenac II, a vessel used to transport people and goods from the mainland to the island, is a significant background noise contributor near the town of Stella. Stella, the largest populated center on the island, is located in the middle of the northern side of the Project. Most of the noise receptors on the island are located along its shoreline.

### 2.3 Approach to the Study

The sound pressure levels at the Points of Reception (POR) used to model the noise receptors were predicted using procedures from ISO 9613-2, which is a widely used standard for evaluation of noise impact in environmental assessments referenced in the Noise Guidelines for Wind Farms document [3].

The sound power levels for the WTGs were provided by Siemens, and are included in Appendix B. This information is presented as frequency spectra from 63 Hz to 8,000 Hz, for wind speeds from 6 to 10 m/s.

At this stage of project design, the transformer manufacturer has not been selected. Thus, the sound power level was estimated based on the National Electrical Manufacturers Association (NEMA) standard, which represents a worst-case scenario (highest sound emissions) for the transformers.

The software package CADNA-A, which implements ISO 9613-2 standard recommended by the MOE in Reference [3], was used to predict the noise levels at the POR. Some of the CADNA-A configurations recommended by MOE that were used in the modeling are shown in Figure 2.1, with more details available in Appendix D. The height contours for the area were taken from the Ontario Base Maps (“OBM”). Any obstacle, (ground surface or physical barrier) that did not break the source-POR line of site was not taken into account as attenuation contribution (no negative path difference).

For modelling purposes, the vegetation and other obstacles (such as barns) that block some of the POR from the sources have not been incorporated. Exclusion of these obstacles from the model results in more conservative sound pressure levels predicted at the POR. In reality, these obstacles may help reduce noise impact at the POR.

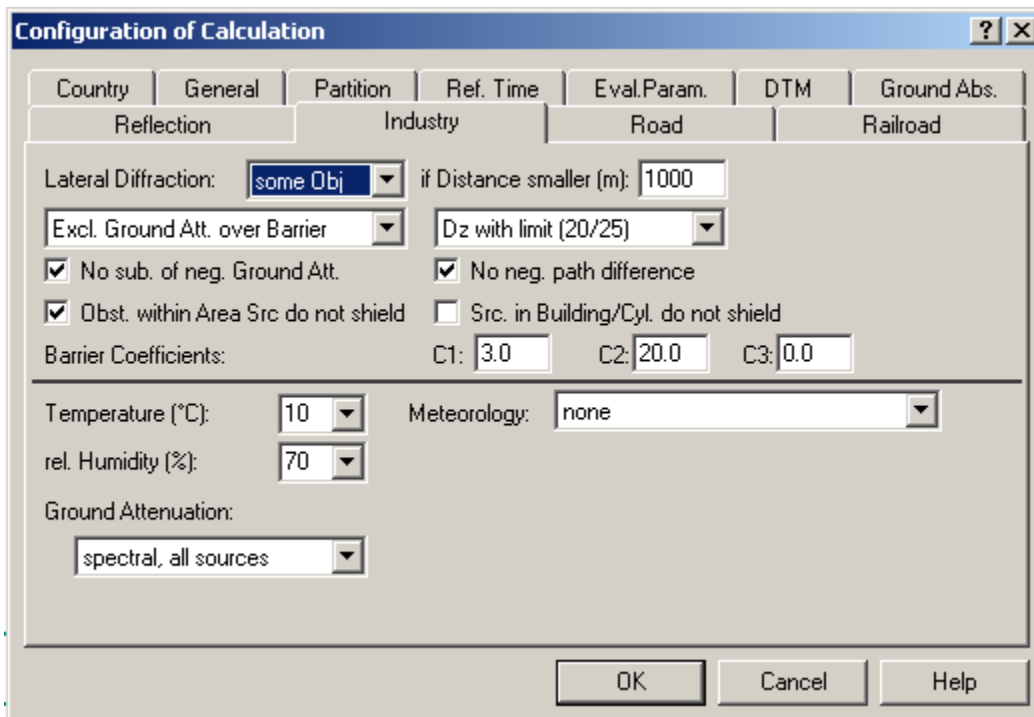

Figure 2.1 CADNA-A Configurations

### 3. Noise Sources

A total of 36 Amherst Island Wind Project WTGs and one substation transformer were evaluated in this study. Table B.1 and Table B.2 in Appendix B present the coordinates of each source included in the model. The sound power levels of the sources are listed in Table B.6.

#### 3.1 Substation Transformer

The Proponent will have one substation containing one 34.5-kV/115-kV/85-MVA transformer as part of the Project. The 34.5-kV electrical power generated by the WTGs will be stepped up to 115-kV by the transformer.

Since the transformer make and model have not been selected at this point, although it is known that the transformer will be of ONAF (oil natural air forced) type, a conservative estimate of sound power level was based on the data from NEMA TRI – 1993 (2000) with a reference sound-producing surface area of 62.9-m<sup>2</sup>. This standard provides the maximum sound level values for transformers, and manufacturers routinely meet this specification. The results, based on NEMA, will slightly overestimate the impact on the POR since the actual transformer to be procured for the project will be below the NEMA specified sound levels.

The NEMA levels were converted into frequency spectra using empirical correlations for transformer noise [4]. This calculation is available in Figure B.1 of Appendix B. The basic transformer dimensions are expected to be similar to those shown in Figure B.2. The noise source height representing the transformer was assumed at 4.0 m above ground level.

Power transformers are considered by the MOE to be tonal noise sources. A 5-dB penalty was added to the sound power spectrum, as recommended by Publication NPC-104, “Sound Level Adjustments” for tonality [8]. Table B.6 in Appendix B shows the frequency spectrum used to model the substation transformer.

The Proponent is committed to installing a transformer that will emit the same, or lower, noise levels than the one modeled.

#### 3.2 Unit Transformers

Each WTG has a 34.5-kV unit transformer located outside of the tower right beside the tower base. These transformers are not considered significant noise sources relative to WTGs, as stated by the MOE Guidelines for Wind Farms [3].

#### 3.3 Wind Turbine Generators

The Proponent is planning to permit a total of thirty six (36) locations, where twenty one (21) Siemens SWT-2.3-113 and fifteen (15) SWT-2.221-113 wind turbine generators are modelled. The basic characteristics of the SWT-2.3-113 and SWT-2.221-113 models are presented in Table 3.1. More technical details on the WTGs, including acoustical data provided by Siemens, can be found in Appendix B. WTG coordinates are presented in Table B.1 while sound power level spectra used in the modeling are available in Table B.6. According to the manufacturer and Reference [3], wind turbines do not present any tonality issues; therefore no tonality penalty was added to the sound power spectrum.

The decision regarding which three of the 36 WTG locations to be excluded will be made based on optimization and agency consultations. Removal of three WTGs will further reduce the overall noise impact from the Project.

**Table 3.1 Basic Characteristics of Siemens SWT-2.3-113 and SWT-2.221-113 WTG Models**

	SWT-2.3-113	SWT-2.221-113
Official model name as provided by Siemens*	SWT-2.3-113 rev1, Max Power 2300 kW	SWT-2.3-113 rev1, Max Power 2221 kW
Type	3-bladed, horizontal axis	3-bladed, horizontal axis
Hub height	99.5 m	99.5 m
Nominal capacity	2.3 MW	2.221 MW
Total maximum sound power	105 dBA	104 dBA
Rotor diameter	113 m	113 m
Swept area	10,000 m <sup>2</sup>	10,000 m <sup>2</sup>
Blade length	55 m	55 m
Rotor chord	4.2 m	4.2 m
Rotor tilt	6 deg	6 deg
Rotor speed range	6–13 rpm	6–13 rpm
Cut-in wind speed	11 km/h (3 m/s)	11 km/h (3 m/s)
Nominal wind speed	45 km/h (12.5 m/s)	45 km/h (12.5 m/s)
Cut-out wind speed	90 km/h (25 m/s)	90 km/h (25 m/s)

\*“SWT-2.3-113 rev1, Max Power 2300 kW” model has been referred in the report as SWT-2.3-113 and “SWT-2.3-113 rev1, Max Power 2221 kW” model has been referred in the report as SWT-2.221-113

### 3.3.1 Adjustment to Wind Turbine Generator Acoustic Emissions for Wind Speed Profile

The acoustical data provided by Siemens was adjusted to the site specific conditions, and is available in Table B.5 and Table B.6. The acoustical data used in the analysis (Table B.6) is equivalent to the maximum sound emissions reported by Siemens, which corresponds to the wind speed of 7 m/s for SWT-2.3-113 model and 6 m/s for SWT-2.221-113 model. These noise emissions were tested in accordance with IEC 61400-11.

### 3.4 Adjacent Wind Farms

The closest wind farms proposed in the vicinity of the Project are Ernestown and Dorland, both located on the mainland, north and northwest of the Project, respectively. The information regarding these adjacent wind projects was obtained from their official web sites

<http://www.ernestownwind.com> and [http://www.gileadpower.com/projects\\_eastern\\_dorland.htm](http://www.gileadpower.com/projects_eastern_dorland.htm).

Ernestown wind farm is a 10-MW project containing five WTGs. The shortest distance from the Ernestown WTGs to the Amherst Island Wind Project noise receptors is 5,260 m.

Dorland wind farm is an 80-MW project for which no layout is publicly available. Since no data on the WTG locations can be presently obtained, the Dorland project site boundary, available at the web site, was used as a reference. It was determined that the closest Amherst Island Wind Project noise receptor is located at 5,574 m from the Dorland project site boundary.

Following the Noise Guidelines for Wind Farms document [3], no noise contribution from the adjacent wind farms was taken into account since there are no adjacent WTGs at less than 5,000 m from the Project noise receptors.

## 4. Noise Receptors and Points of Reception

The noise receptors modeled in the study were obtained using Ontario Base Maps, high-resolution satellite imagery, and data from site inspections. The Loyalist municipality was contacted for the approved building permits and all corresponding locations were considered as noise receptors. Also, the noise receptors corresponding to the vacant lots were added based on parcel information provided by First Base Solutions (Teranet Data - 2012) and located according to the requirements outlined in Ontario Regulation 359/09, and its amendment Ontario Regulation 521/10.

The noise receptors were represented by points of reception (POR) in the CADNA model. Each noise receptor was modeled by two POR: one placed in the middle of the receptor footprint and elevated at 4.5 m above ground; and another one by a point located within 30-m distance from the receptor center where the sound pressure is maximum at 1.5-m above ground elevation.

The minimum distance between WTGs and non-participating noise receptors was kept above 550 m. The minimum distance from the existing participating noise receptors was kept at 400 m. No distance restrictions were applied for the participating vacant lot noise receptors. The distances were measured between the noise receptor footprint center and WTG tower center.

The total number of noise receptors located within 1,500 m from any of the Project WTGs and within 1,000 m from the Project substation is 488. As specified by the Noise Guidelines for Wind Farms, the noise receptors were classified as either participating or non-participating. Participating noise receptors correspond to land owners that have some infrastructure on their property. Infrastructure includes wind turbine generators, substation, underground collector cables, access roads, operation and maintenance building, and storage building. For this Project, there are a total of 51 participating noise receptors. All other potential noise receptors (437) are considered non-participating for the purpose of verifying compliance with the MOE guidelines.

## 5. Mitigation Measures

An acoustical barrier is required at the substation transformer in order to achieve noise compliance at the noise receptors located in the vicinity of the substation. The material for the barriers was assumed to be Durisol Richmond Panel manufactured by Armtec. Table B.3 in Appendix B presents absorption coefficients used in the CADNA-A model, while Figure B.2 shows details of the proposed barrier. The barrier will be continuous and its surface density will be  $184 \text{ kg/m}^2$ , exceeding the  $20\text{-kg/m}^2$  requirement established by MOE. More information on the Durisol Richmond Panel can found in Appendix B. The Proponent is committed to using barrier material which will have equivalent or higher absorption coefficients than those used in the modeling.

Table B.4 lists UTM coordinates, height, and length of the substation barrier as it was modeled in CADNA-A.

## 6. Noise Impact Assessment

The purpose of the acoustic assessment report is to demonstrate that the Project is in compliance with the noise performance limits. All noise receptors considered in the study were assumed to be located in Class 3 areas as defined in Publication NPC-232 by the MOE. A Class 3 area means a rural area with an acoustical environment that is dominated by natural sounds having little or no traffic. Table 6.1 shows the performance limits set by the MOE for Class 3 areas, according to Noise Guidelines for Wind Farms publication.

**Table 6.1 Sound Pressure Limits for Class 3 Areas**

Wind Speed at 10-m Height [m/s]	4	5	6	7	8	9	10
POR sound pressure limits (dBA)	40.0	40.0	40.0	43.0	45.0	49.0	51.0

For this study, the overall ground attenuation coefficient was assumed to be 0.7, as recommended by the MOE for evaluating the noise impact of renewable energy facilities. The maximum sound pressure level specified at 6 m/s (40.0 dBA) was used as the compliance criterion for the POR representing non-participating noise receptors.

As outlined by Section 6.7 of the Noise Guidelines for Wind Farms (MOE 2008), a manual calculation was carried out to confirm the results obtained using CADNA-A for a single source-POR pair. For this Project, MathCAD was used as a calculating tool, and the source-POR pair selected was S11 and POR at 4.5 m representing R080 noise receptor. R080 is a non-participating noise receptor located 575 m from wind turbine generator S11. The MathCAD printout is included in Appendix D and confirms the results of the CADNA-A model. In addition, a sample calculation from the CADNA-A model for R080 is provided in Appendix D to demonstrate the outputs as well as the inputs placed into the CADNA-A software.

### 6.1 Compliance with Performance Limits

Table C.1 in Appendix C presents calculated sound pressure levels at the POR corresponding to non-participating noise receptors and it also lists distances to the nearest noise sources. Table C.2 lists results for the POR representing participating noise receptors. Figure C.1 displays sound pressure contours calculated at 4.5 m. Figure C.2, presented in A0 size, shows more detail regarding setback from wind turbines and property lines, along with the 40 dBA contour line (as per MOE's request on August 28, 2013). Satellite imagery was not added for clarity of the other elements.

The findings of this study show that all non-participating noise receptors are compliant with MOE guidelines based on the performance limit of 40 dBA and 550-m noise receptor-WTG distance.



## 7. Conclusions and Recommendations

For the Amherst Island Wind Project, the sound pressure levels at the noise receptors have been estimated using the CADNA-A model based on ISO 9613-2. The performance limits used for comparison correspond to Class 3 areas with 40.0-dBA limit.

Based on the results obtained in this study it is concluded that the sound pressure levels, resulting from the Amherst Island Wind Project operation based on 36 WTG locations and one substation transformer, at the noise receptors located within 1,500 m from any of the Project wind turbine generators and within 1,000 m from the Project substation will be compliant with the MOE requirements for Class 3 areas of 40.0 dBA at all times. The removal of three WTGs will further reduce the overall noise impact from the Project.

## 8. References

- [1]. Ontario Regulation 359/09; Environmental Protection Act; Renewable Energy Approvals under Part V.0.1 of the Act.
- [2]. Ontario Regulation 521/10 made under the Environmental Protection Act; Amending Ontario Regulation 359/09.
- [3]. Noise Guidelines for Wind Farms; Interpretation for Applying MOE NPC Publications to Wind Power Generation Facilities; Ministry of the Environment; October 2008.
- [4]. Robert D. Stevens; Chris Hung; Toward A Realistic Estimate of Octave Band Sound Levels for Electric Transformers
- [5]. NEMA; Standards Publication No. TR 1-1993 (R2000); Transformers, Regulators and Reactors; National Electrical Manufacturers Association.
- [6]. ISO 1996-1 Description; Measurement and Assessment of Environmental Noise – Part 1; Basic Quantities and Assessment Procedures.
- [7]. International Organization for Standardization (ISO). Standard 1913-2: Acoustics – Attenuation of sound during propagation outdoors – Part 2: General Method of Calculation
- [8]. NPC-104, "Sound Level Adjustments," Ontario Ministry of the Environment
- [9]. MOE 1995; Sound Level Limits for Stationary Sources in Class 3 Areas (Rural); Publication NPC-232; Ontario Ministry of the Environment.
- [10]. MOE 1995; Sound Level Limits for Stationary Sources in Class 1 & 2 Areas (Urban); Publication NPC-205; Ontario Ministry of the Environment.

# Appendix A

## Geographic Location of Project Study Area, Wind Farm Layout, Land Use Schedule

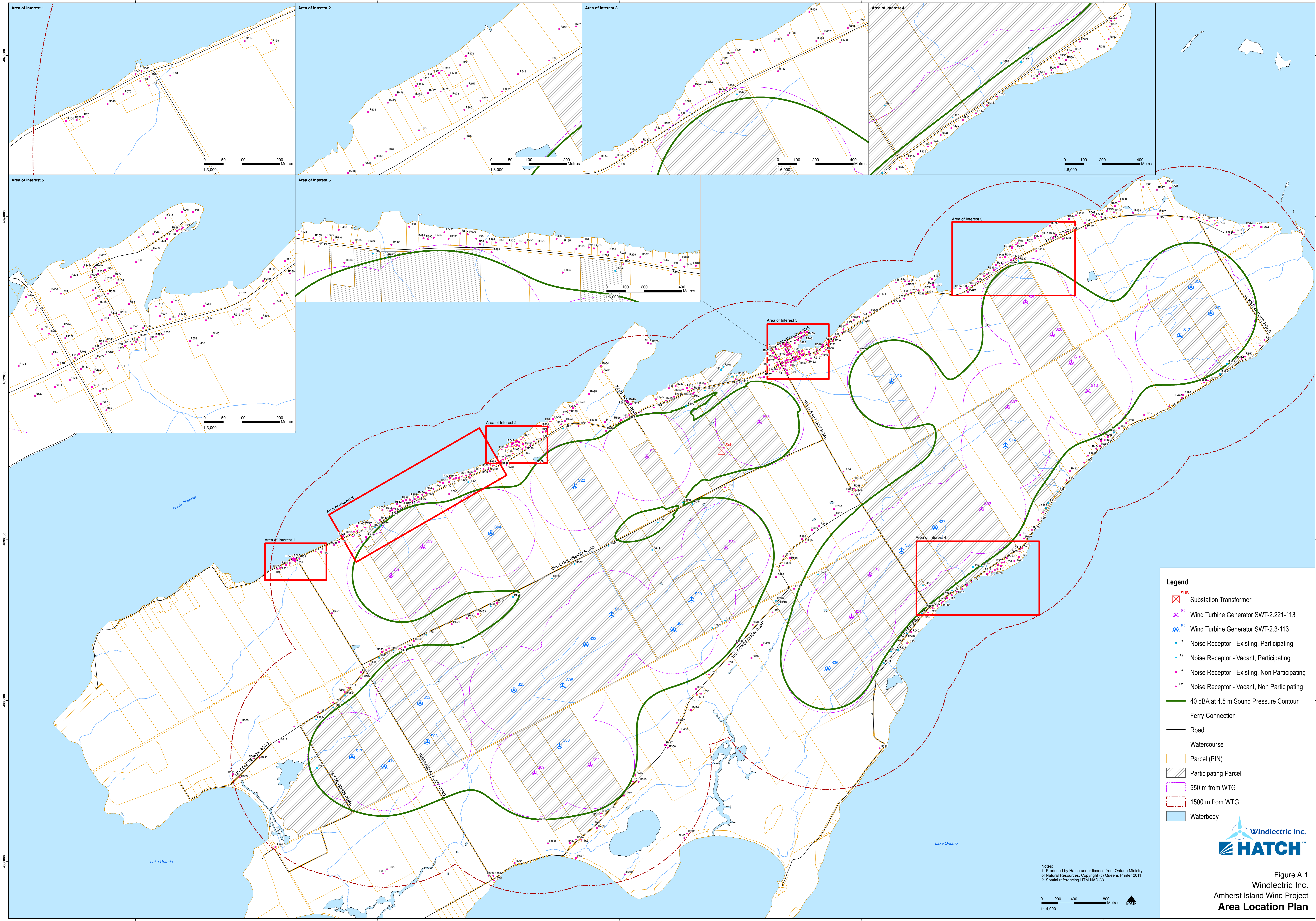

- Legend**
- ⊠ SUB Substation Transformer
  - ⊠ S<sub>1</sub> Wind Turbine Generator SWT-2.221-113
  - ⊠ S<sub>2</sub> Wind Turbine Generator SWT-2.3-113
  - ⊠ R<sub>1</sub> Noise Receptor - Existing, Participating
  - ⊠ R<sub>2</sub> Noise Receptor - Vacant, Participating
  - ⊠ R<sub>3</sub> Noise Receptor - Existing, Non Participating
  - ⊠ R<sub>4</sub> Noise Receptor - Vacant, Non Participating
  - 40 dBA at 4.5 m Sound Pressure Contour
  - Ferry Connection
  - Road
  - Watercourse
  - Parcel (PIN)
  - Participating Parcel
  - 550 m from WTG
  - 1500 m from WTG
  - Waterbody

Notes:  
 1. Produced by Hatch under licence from Ontario Ministry of Natural Resources. Copyright (c) Queens Printer 2011.  
 2. Spatial referencing UTM NAD 83.

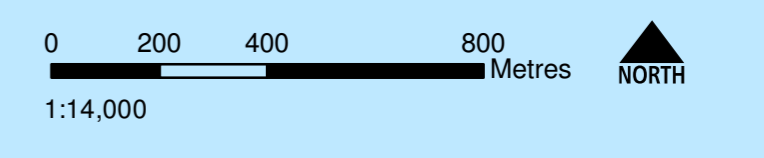
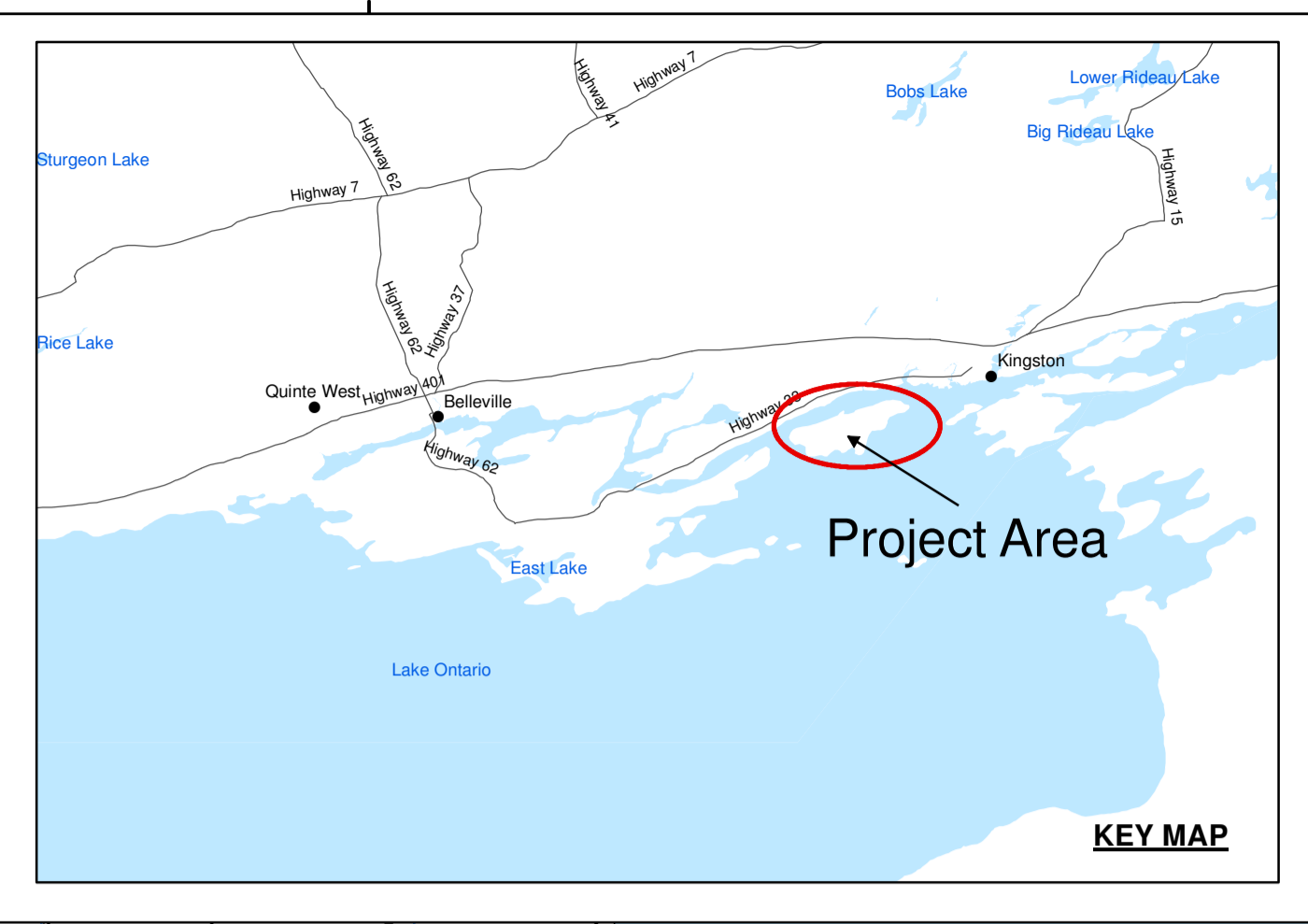
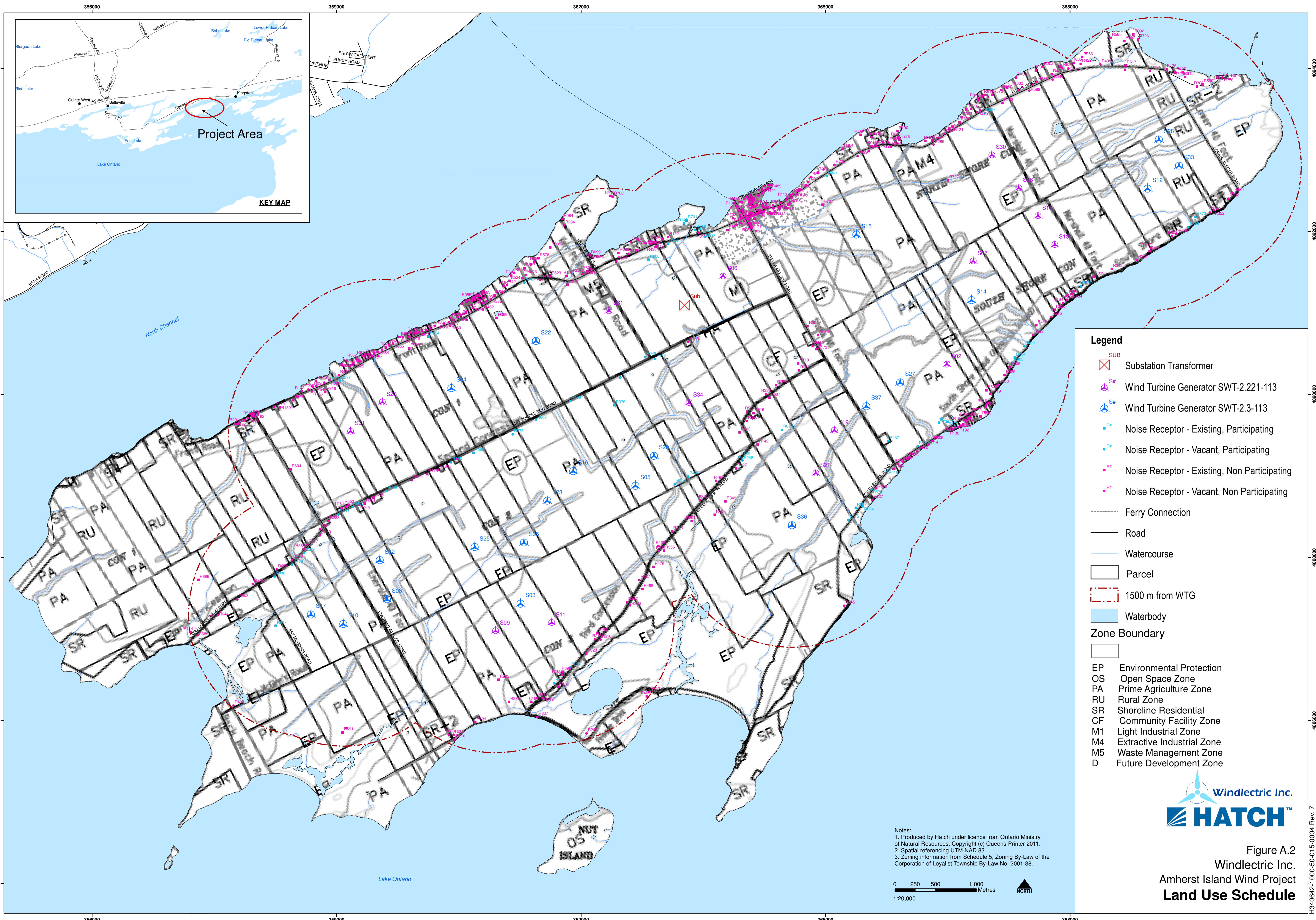

Figure A.1  
 Windetric Inc.  
 Amherst Island Wind Project  
**Area Location Plan**



- Legend**
- SUB Substation Transformer
  - SR Wind Turbine Generator SWT-2.221-113
  - SR Wind Turbine Generator SWT-2.3-113
  - NR Noise Receptor - Existing, Participating
  - NR Noise Receptor - Vacant, Participating
  - NR Noise Receptor - Existing, Non Participating
  - NR Noise Receptor - Vacant, Non Participating
  - Ferry Connection
  - Road
  - Watercourse
  - Parcel
  - 1500 m from WTG
  - Waterbody
  - Zone Boundary**
  - EP Environmental Protection
  - OS Open Space Zone
  - PA Prime Agriculture Zone
  - RU Rural Zone
  - SR Shoreline Residential
  - CF Community Facility Zone
  - M1 Light Industrial Zone
  - M4 Extractive Industrial Zone
  - M5 Waste Management Zone
  - D Future Development Zone

Notes:  
 1. Produced by Hatch under licence from Ontario Ministry of Natural Resources, Copyright (c) Queens Printer 2011.  
 2. Spatial referencing UTM NAD 83.  
 3. Zoning information from Schedule 5, Zoning By-Law of the Corporation of Loyalist Township By-Law No. 2001-38.

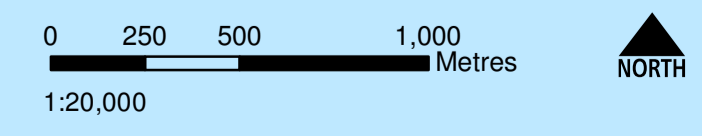

Figure A.2  
 Windlectric Inc.  
 Amherst Island Wind Project  
**Land Use Schedule**

# Appendix B

## Noise Sources

**Table B.1 Wind Turbine Generator List (36 WTGs).**

ID	Equipment make and model	UTM NAD 83, Zone 18		Spectra ID	Total sound power [dBA]	Height [m]
		X[m]	Y[m]			
S01	Siemens SWT-2.221-113	359172	4889551	SWT_22_113_6ms	104.0	99.5
S02	Siemens SWT-2.221-113	366489	4890373	SWT_22_113_6ms	104.0	99.5
S03	Siemens SWT-2.3-113	361257	4887434	SWT_23_113_7ms	105.0	99.5
S04	Siemens SWT-2.3-113	360408	4890076	SWT_23_113_7ms	105.0	99.5
S05	Siemens SWT-2.3-113	362668	4888881	SWT_23_113_7ms	105.0	99.5
S06	Siemens SWT-2.221-113	363743	4891454	SWT_22_113_6ms	104.0	99.5
S07	Siemens SWT-2.221-113	366812	4891637	SWT_22_113_6ms	104.0	99.5
S08	Siemens SWT-2.3-113	359618	4887487	SWT_23_113_7ms	105.0	99.5
S09	Siemens SWT-2.221-113	360951	4887104	SWT_22_113_6ms	104.0	99.5
S10	Siemens SWT-2.3-113	359083	4887184	SWT_23_113_7ms	105.0	99.5
S11	Siemens SWT-2.221-113	361641	4887206	SWT_22_113_6ms	104.0	99.5
S12	Siemens SWT-2.3-113	368952	4892526	SWT_23_113_7ms	105.0	99.5
S13	Siemens SWT-2.221-113	367813	4891841	SWT_22_113_6ms	104.0	99.5
S14	Siemens SWT-2.3-113	366790	4891157	SWT_23_113_7ms	105.0	99.5
S15	Siemens SWT-2.3-113	365379	4891960	SWT_23_113_7ms	105.0	99.5
S16	Siemens SWT-2.3-113	361904	4889060	SWT_23_113_7ms	105.0	99.5
S17	Siemens SWT-2.3-113	358685	4887302	SWT_23_113_7ms	105.0	99.5
S18	Siemens SWT-2.221-113	367607	4892193	SWT_22_113_6ms	104.0	99.5
S19	Siemens SWT-2.221-113	365107	4889563	SWT_22_113_6ms	104.0	99.5
S20	Siemens SWT-2.3-113	362894	4889249	SWT_23_113_7ms	105.0	99.5
S21	Siemens SWT-2.221-113	364881	4889039	SWT_22_113_6ms	104.0	99.5
S22	Siemens SWT-2.3-113	361447	4890656	SWT_23_113_7ms	105.0	99.5
S23	Siemens SWT-2.3-113	361586	4888696	SWT_23_113_7ms	105.0	99.5
S25	Siemens SWT-2.3-113	360694	4888128	SWT_23_113_7ms	105.0	99.5
S26	Siemens SWT-2.221-113	367371	4892536	SWT_22_113_6ms	104.0	99.5
S27	Siemens SWT-2.3-113	365916	4890146	SWT_23_113_7ms	105.0	99.5
S28	Siemens SWT-2.3-113	369091	4893127	SWT_23_113_7ms	105.0	99.5
S29	Siemens SWT-2.221-113	359562	4889909	SWT_22_113_6ms	104.0	99.5
S30	Siemens SWT-2.221-113	367040	4892941	SWT_22_113_6ms	104.0	99.5
S31	Siemens SWT-2.221-113	362343	4891028	SWT_22_113_6ms	104.0	99.5
S32	Siemens SWT-2.3-113	359530	4887967	SWT_23_113_7ms	105.0	99.5
S33	Siemens SWT-2.3-113	369337	4892806	SWT_23_113_7ms	105.0	99.5
S34	Siemens SWT-2.221-113	363324	4889901	SWT_22_113_6ms	104.0	99.5
S35	Siemens SWT-2.3-113	361299	4888183	SWT_23_113_7ms	105.0	99.5
S36	Siemens SWT-2.3-113	364589	4888397	SWT_23_113_7ms	105.0	99.5
S37	Siemens SWT-2.3-113	365501	4889854	SWT_23_113_7ms	105.0	99.5

**Table B.2 Location of Substation Transformers.**  
Sound power level includes a 5-dBA tonality penalty.

ID	Description	UTM NAD 83, Zone 18		Spectra ID	Total sound power [dBA]	Height [m]
		X[m]	Y[m]			
Sub	34.5-kV/115-kV/85-MVA substation transformer	363269.13	4891095.48	Tr_34.5kV_115kV_85MW	105.2	4.0

**Table B.3 Absorption Coefficient Spectrum for Acoustical Barrier at the Substation Transformer.**

Material name	Spectra ID	Octave Spectrum									
		31.5	63	125	250	500	1000	2000	4000	8000	Aw
Durisol Richmond Panel	Durisol Richmond	0	0	0.29	0.53	0.97	0.87	0.89	0.90	0	0.8

**Table B.4 Sound Barrier Coordinates.**

Barrier ID	Source ID	Absorption Spectra ID	UTM NAD 83, Zone 18		Length [m]	Height [m]
			X[m]	Y[m]		
Barrier_Sub	Sub	Durisol Richmond	363265.12	4891094.03	17.04	6.0
			363266.88	4891090.09		
			363274.64	4891093.56		
			363272.91	4891097.41		



**Table B.5 Wind Turbine Generator Sound Power Level Adjustment**

<b>Make and Model</b>		Siemens SWT-2.221-113									
<b>Electrical Rating [kW]</b>		2221									
<b>Hub Height [m]</b>		99.5									
<b>Wind Shear Coefficient</b>		0.45									
<b>Octave Band Sound Power Level [dB]</b>											
	<b>Manufacturer's Emissions Levels</b>					<b>Adjusted Sound Power Level</b>					
<b>Wind Speed [m/s]</b>	<b>6</b>	<b>7</b>	<b>8</b>	<b>9</b>	<b>10</b>	<b>6</b>	<b>7</b>	<b>8</b>	<b>9</b>	<b>10</b>	
<b>Frequency [Hz]</b>											
63	111.0	109.8	109.7	109.9	109.6	111.0					
125	107.0	107.4	104.9	104.4	103.6	107.0					
250	106.2	106.3	105.8	105.3	104.5	106.2					
500	101.4	101.2	101.0	100.9	100.6	101.4					
1000	98.8	98.7	98.0	98.0	98.3	98.8					
2000	94.4	94.2	95.9	96.2	96.7	94.4					
4000	83.1	86.8	89.8	91.7	91.9	83.1					
8000	66.7	72.3	75.6	75.7	75.6	66.7					
Combined [dBA]	104.0	104.0	104.0	104.0	104.0	104.0					

<b>Make and Model</b>		Siemens SWT-2.3-113									
<b>Electrical Rating [kW]</b>		2300									
<b>Hub Height [m]</b>		99.5									
<b>Wind Shear Coefficient</b>		0.45									
<b>Octave Band Sound Power Level [dB]</b>											
	<b>Manufacturer's Emissions Levels</b>					<b>Adjusted Sound Power Level</b>					
<b>Wind Speed [m/s]</b>	<b>6</b>	<b>7</b>	<b>8</b>	<b>9</b>	<b>10</b>	<b>6</b>	<b>7</b>	<b>8</b>	<b>9</b>	<b>10</b>	
<b>Frequency [Hz]</b>											
63	111.2	110.8	109.9	110.1	109.8	110.8					
125	107.4	108.5	105.3	104.8	104.0	108.5					
250	105.4	106.2	107.0	106.4	105.7	106.2					
500	102.1	102.6	102.5	102.4	102.1	102.6					
1000	99.7	100.3	98.9	98.9	99.2	100.3					
2000	94.1	94.7	96.7	97.0	97.5	94.7					
4000	83.9	85.1	89.8	91.7	92.0	85.1					
8000	68.5	69.2	75.5	75.6	75.5	69.2					
Combined [dBA]	104.4	105.0	105.0	105.0	105.0	105.0					

**Table B.6 Sound Power Spectra Used for Modelling the Noise Sources.**

The WTG spectra are site adjusted. The data does not include tonality penalties for the transformer.

Spectra ID	Description	Octave spectrum [dBA]									
		31.5	63	125	250	500	1000	2000	4000	8000	Total
SWT_22_113_6ms*	Provided by Siemens for SWT-2.221-113 model for 6-m/s wind speed		84.8	90.9	97.6	98.2	98.8	95.6	84.1	65.6	104.0
SWT_23_113_7ms*	Provided by Siemens for SWT-2.3-113 model for 7-m/s wind speed		84.6	92.4	97.6	99.4	100.3	95.9	86.1	68.1	105.0
Tr_34.5kV_115kV_85MW	Estimated for 34.5-kV/115-kV/85-MW transformer using sound levels from NEMA TR 1-1993 (R2000) and empirical equations from Stevens & Hung paper	55.6	72.8	85.9	91.4	96.8	94.0	90.2	85.0	74.9	100.2

\*for both models (SWT-2.3-113 and SWT-2.221-113) different wind speeds and combinations were tested as per data provided by Siemens. The results show that the worst case scenario corresponds to the combination of 7 m/s for SWT-2.3-113 and 6 m/s for SWT-2.221-113.

## Estimated Frequency Spectra for Transformers

### Substation transformer - 34.5kV/115kV/85MVA - Oil filled

From Robert D. Stevens and Chris Hung, "Toward a realistic estimate of octave band sound levels for electrical transformers" paper

Average LpA	82.0 dBA	Based on NEMA TR1-1993 (R2000), Table 0-2, immersed power transformers
Ref. Sound Producing Surface Area:	62.9 m <sup>2</sup>	Estimated based on similar transformer dimensions and similar methodology as described in IEEE C57.12.90-2010

Correction factors to be used with meters<sup>2</sup>

Freq. [Hz]	31	63	125	250	500	1000	2000	4000	8000
Correction [dB]	-5.0	-1.0	2.0	0.0	0.0	-6.0	-11.0	-16.0	-24.0

Sound Power Level calculated as  $L_w = \text{Average } L_pA + 10 \cdot \log(\text{Estimated surface area in m}^2) + C$

Freq. [Hz]	31	63	125	250	500	1000	2000	4000	8000	Combined [dB]
Sound Power, Lw [dB]	95.0	99.0	102.0	100.0	100.0	94.0	89.0	84.0	76.0	107.0

Resulting A-weighted sound power level, LwA

Freq. [Hz]	31	63	125	250	500	1000	2000	4000	8000	Combined [dBA]
A-Weight [dB]	-39.4	-26.2	-16.1	-8.6	-3.2	0.0	1.2	1.0	-1.1	-
Sound Power, LwA [dBA]	55.6	72.8	85.9	91.4	96.8	94.0	90.2	85.0	74.9	100.2

Figure B.1 Substation transformer sound power calculations.

## SWT-2.3-113, Rev. 1, Max. Power 2300 kW Contract Acoustic Emission, Hub Height 99.5 m Ontario - Canada

### Sound Power Levels

The warranted sound power level is presented with reference to the code IEC 61400-11:2002 with amendment 1 dated 2006-05 based on a hub height of 99.5 m and a roughness length of 0.05 m as described in the IEC code. The sound power levels (LWA) presented are valid for the corresponding wind speeds referenced to a height of 10 m above ground level.

Wind speed [m/s]	4	5	6	7	8	9	10	11	12	Up to cut-out
Max. Power 2300kW	96.6	102.6	104.4	105.0	105.0	105.0	105.0	105.0	105.0	105.0

Table 1: Acoustic emission,  $L_{WA}$  [dB(A) re 1 pW]

### Typical Sound Power Frequency Distribution

Typical spectra for  $L_{WA}$  in dB(A) re 1pW for the corresponding centre frequencies are tabulated below for 6 - 10 m/s referenced to a height of 10.0 m above ground level.

Octave band, centre frequency [Hz]	Wind Speed (m/s)				
	6	7	8	9	10
63	85.0	84.6	83.7	83.9	83.6
125	91.3	92.4	89.2	88.7	87.9
250	96.8	97.6	98.4	97.8	97.1
500	98.9	99.4	99.3	99.2	98.9
1000	99.7	100.3	98.9	98.9	99.2
2000	95.3	95.9	97.9	98.2	98.7
4000	84.9	86.1	90.8	92.7	93.0
8000	67.4	68.1	74.4	74.5	74.4

Table 2: Typical octave bands for 6-10 m/s,  $L_{WA}$  [dB(A) re 1 pW]

### Tonality

Typical tonal audibility for the Siemens wind turbine generators has not exceeded 2 dB as determined in accordance with IEC 61400-11:2002.

### Measurement Uncertainty

A measurement uncertainty range of -1.5dB(A) to +1.5dB(A) is applicable.

## SWT-2.3-113, Rev. 1, Max. Power 2221 kW Contract Acoustic Emission, Hub Height 99.5 m Ontario - Canada

### Sound Power Levels

The warranted sound power level is presented with reference to the code IEC 61400-11:2002 with amendment 1 dated 2006-05 based on a hub height of 99.5 m and a roughness length of 0.05 m as described in the IEC code. The sound power levels (LWA) presented are valid for the corresponding wind speeds referenced to a height of 10 m above ground level.

Wind speed [m/s]	4	5	6	7	8	9	10	11	12	Up to cut-out
Max. Power 2221kW	96.6	102.6	104.0	104.0	104.0	104.0	104.0	104.0	104.0	104.0

Table 1: Acoustic emission,  $L_{WA}$  [dB(A) re 1 pW]

### Typical Sound Power Frequency Distribution

Typical spectra for  $L_{WA}$  in dB(A) re 1pW for the corresponding centre frequencies are tabulated below for 6 - 10 m/s referenced to a height of 10.0 m above ground level.

Octave band, centre frequency [Hz]	Wind Speed (m/s)				
	6	7	8	9	10
63	84.8	83.6	83.5	83.7	83.4
125	90.9	91.3	88.8	88.3	87.5
250	97.6	97.7	97.2	96.7	95.9
500	98.2	98.0	97.8	97.7	97.4
1000	98.8	98.7	98.0	98.0	98.3
2000	95.6	95.4	97.1	97.4	97.9
4000	84.1	87.8	90.8	92.7	92.9
8000	65.6	71.2	74.5	74.6	74.5

Table 2: Typical octave bands for 6-10 m/s,  $L_{WA}$  [dB(A) re 1 pW]

### Tonality

Typical tonal audibility for the Siemens wind turbine generators has not exceeded 2 dB as determined in accordance with IEC 61400-11:2002.

### Measurement Uncertainty

A measurement uncertainty range of -1.5dB(A) to +1.5dB(A) is applicable.



SIEMENS



SWT - 2.3 - 113

Turning moderate wind into maximum results

# At the leading edge of evolution

The new Siemens SWT-2.3-113 wind turbine is the ultimate choice for low to moderate wind conditions. The revolutionary direct drive generator and the new, optimized Quantum Blade are paired to extract as much energy as possible from the wind.

Efficient. Quiet. Robust and reliable. The Siemens SWT-2.3-113 is the new benchmark wind turbine for low to medium wind speeds. As a result of more than 30 years of research and development, it is designed to harvest more energy out of moderate wind conditions than anyone thought possible.

## Proven design

The SWT-2.3-113 is built around the same revolutionizing direct drive generator as the SWT-3.0-101. The direct drive turbine offers exceptional reliability and efficiency – with only 50% of the parts normally required for a conventional wind turbine. By using the same proven design and sharing the majority of components with its larger sibling, production costs and lead times can be kept down.

## Unique aerodynamics

The Quantum Blade combines exceptional aerodynamic performance with patented manufacturing technology. Based on innovative aerodynamic solutions in the root and tip sections, the Quantum Blade offers maximum efficiency at low to medium wind speeds.

## Maximum availability

Simplicity is the ultimate sophistication. With the simple and robust direct drive concept with 50% fewer parts, the SWT-2.3-113 wind turbine is designed for maximum availability. Furthermore, the spacious nacelle and the ergonomic working conditions facilitate serviceability and contribute to minimizing downtime for scheduled maintenance.

“

You cannot change the wind.  
It may be strong, it may be light.  
This leaves it up to us to extract  
as much energy as we can from it.

*Anne Schannong Vinther, Quality Engineer*





# Innovation for efficiency

Siemens direct drive technology and the new Quantum Blade represent groundbreaking wind turbine design and technology. The result of these two key innovations is a turbine with maximum efficiency and reliability, which helps to enable a solid return on investment.

## Maximized performance with 50% fewer parts

The Siemens direct drive design incorporates a permanent magnet generator with fewer moving parts than ever before.

The simple permanent magnet design offers increased efficiency directly by minimizing energy losses and indirectly by reducing maintenance needs. The outer rotor arrangement leads to a more compact and lightweight generator, making transportation and installation easier and faster.

## The B55 Quantum Blade

The new generation of Siemens wind turbine blades is lighter than previous designs but retains the superior

strength known from earlier generations of blades. Thanks to unique airfoils and redesigned tip and root sections, the blade offers superior performance at low to medium wind speeds. The root section uses Siemens "flatback" profiles to minimize root leakage and provide higher lift. The tip has also undergone a fine-tuning process to give enhanced lift and acoustic performance.

## One-piece moulding

Like other Siemens blades, the new Quantum Blades are manufactured in Siemens proprietary IntegralBlade® process. Each blade is moulded in one single production step from fiberglass-reinforced epoxy resin, resulting in a stronger, lighter blade without any joints.



## Lower noise

With a low 105 dB noise level, the SWT-2.3-113 is one of the quietest wind turbines on the market. As a result, this turbine type has an extremely high ratio of energy output per noise affected area, resulting in fewer disturbances to people and wildlife.

## Superior grid compliance

The Siemens NetConverter® is designed for maximum flexibility in the turbine's response to voltage and frequency variations, fault ride-through capability and output adjustment. The advanced wind farm control system provides state-of-the-art fleet management.

# Technical specification

## Rotor

- Type: 3-bladed, horizontal axis
- Position: Upwind
- Diameter: 113 m
- Swept area: 10,000 m<sup>2</sup>
- Speed range: 6–13 rpm
- Power regulation: Pitch regulation with variable speed
- Rotor tilt: 6 degrees

## Blade

- Type: Self-supporting
- Blade length: 55 m
- Tip chord: 0.63 m
- Root chord: 4.2 m
- Aerodynamic profile: NB 1-7, SWPNA1\_XX12, FFAxxx
- Material: GRE
- Surface gloss: Semi-mat, <30 / ISO2813
- Surface colour: Light grey, RAL 7035

## Aerodynamic brake

- Type: Full span pitching
- Activation: Active, hydraulic

## Load-supporting parts

- Hub: Nodular cast iron
- Main shaft: Cast
- Nacelle bed plate: Cast

## Sales power curve

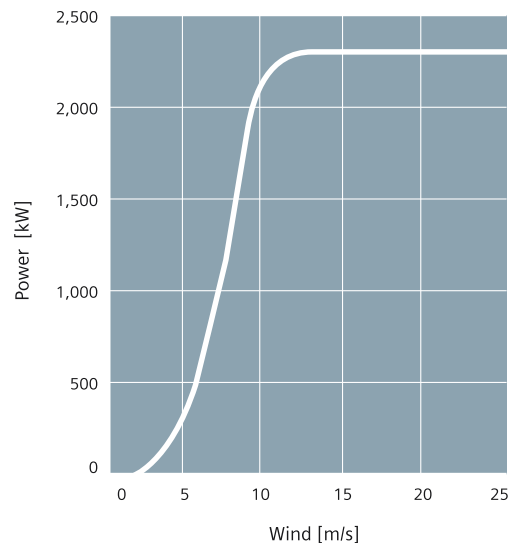

## Mechanical brake

- Type: Hydraulic disc brake
- Position: Generator rear end
- Number of callipers: 3

## Canopy

- Type: Totally enclosed
- Surface gloss: Silk mat, 30–40 / ISO2813
- Colour: Light grey, RAL 7035

## Generator

- Type: Synchronous, PMG
- Nominal power: 2,300 kW

## Grid terminals (LV)

- Nominal power: 2,300 kW
- Voltage: 690 V
- Frequency: 50 Hz or 60 Hz

## Yaw system

- Type: Active
- Yaw bearing: Externally geared
- Yaw drive: 8 (optional 10) electric gear motors
- Yaw brake: Passive friction brake

## Controller

- Type: Microprocessor
- SCADA system: WPS
- Controller designation: SWTC, STC-1, SCS-1

## Tower

- Type: Cylindrical and/or tapered tubular
- Hub height: 99.5 m or site-specific
- Corrosion protection: Painted
- Surface gloss: Silk mat, 30–40 / ISO2813
- Colour: Light grey, RAL 7035

## Operational data

- Cut-in wind speed: 3 m/s
- Nominal power at: 12–13 m/s
- Cut-out wind speed: 25 m/s
- Maximum 3 s gust: 59.5 m/s (IEC version)

## Weights (approximately)

- Rotor: 66,700 kg
- Nacelle: 73,000 kg
- Tower: Site-specific

1

### Quantum Blade

- Unique design and manufacturing process
- IntegralBlade® one-piece moulding for maximum strength
- Optimized aerodynamics for low to medium wind conditions
- Increased length for higher energy yield
- Blade root – designed for minimized root leakage and increased lift

2

### Direct drive generator

- Permanent magnet design
- Totally enclosed, easy to handle and lightweight design
- Optimum reliability and efficiency

3

### Nacelle

- Solid, compact and lightweight structure
- Spacious, ergonomic design – maximum serviceability
- 50% fewer parts compared to geared turbines

4

### Cooling

- Simple and robust LiquidLink® water cooling system
- Top-mounted passive cooling radiators
- High-efficient two-stage cooling as function of power



Published by and copyright © 2011:  
Siemens AG  
Energy Sector  
Freyeslebenstrasse 1  
91058 Erlangen, Germany

Siemens Wind Power A/S  
Borupvej 16  
7330 Brande, Denmark  
[www.siemens.com/wind](http://www.siemens.com/wind)

For more information, please contact  
our Customer Support Center.  
Phone: +49 180 524 70 00  
Fax: +49 180 524 24 71  
(Charges depending on provider)  
E-mail: [support.energy@siemens.com](mailto:support.energy@siemens.com)

Renewable Energy Division  
Order No. E50001-W310-A174-X-4A00

Printed in Germany  
Dispo 34804, c4bs No. 7491  
LN 13982 WS 03113.0  
Printed on elementary chlorine-free  
bleached paper.

All rights reserved.  
Trademarks mentioned in this document  
are the property of Siemens AG, its affiliates,  
or their respective owners.

Subject to change without prior notice.  
The information in this document contains  
general descriptions of the technical options  
available, which may not apply in all cases.  
The required technical options should therefore  
be specified in the contract.

# TEST REPORT SUMMARY



This is a summary of the test report P6.024.12. The full test report has 26 pages in total.

## Summary:

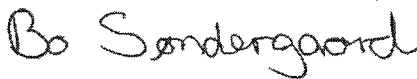
<b>Acoustic Noise, Wind Turbine</b> Siemens SWT 2.3-113. Power curve revision 1	
Report no.: P6.024.12 Aarhus 17. August 2012 Project: 35.6342.08	
Client: Siemens Wind Power A/S Borupvej 16 DK-7330 Brande Denmark	Commissioned by: Tomas R. Hansen  Telephone: +45 9942 2605
Prepared by: Bo Søndergaard  Checked by: Peter Henningsen	Signatory:  Bo Søndergaard

For the Siemens wind turbine type SWT 2.3-113, serial number 2305083, the following acoustic data has been determined according to IEC 61400-11 Edition 2.1:

Standardized wind speed	[m/s]	5	6	7	8*	9*	10*
Power	[kW]	1088	1806	2248	2298	2300	2300
Apparent Sound Power Level							
$L_{WA}$	[dB re 1 pW]	100,2	102,0	102,5	102,4	102,2	102,3
Uncertainty $U_c$	[dB]	1,2	0,9	1,1	1,1	1,2	1,3
Tonal Audibility $\Delta L_a$	[dB]	-	-4,3	-10,9	-7,0	-6,9	-11,3

\* correspond to more than 95% of rated power.

Third octave band spectra are included in the full report

The measurements were carried out on 17 to 18 June 2012, at Høvsøre Test Site Denmark.



Acoustica Acoustics · Noise · Vibrations

Dusager 12  
DK 8200 Århus N  
Denmark

Phone +45 8210 5100  
Direct phone +45 8210 5149  
Mobile phone +45 2723 5149

Web www.grontmij.dk  
E-mail bo.sondergaard@grontmij.dk  
File AD0EDEA2.tmp

CVR-no. 48233511

# SIEMENS

June 13, 2014

To: Ontario Ministry of Environment

Re: Amherst Island Wind Project

Dear Sir / Madam:

With respect to the Amherst Island Wind Project, Siemens Canada Limited ("Siemens") will provide its SWT D3 Direct Drive wind turbine generators, with a maximum power output of both 2,300 kW for certain Units and 2,221 kW for other Units, as applicable for the Project Site. In accordance with the Turbine Supply Agreement between Siemens and Algonquin Power, Siemens will guarantee the maximum broadband sound power levels for those Units at their respective maximum rated power levels shown in the table below.

	Maximum Rated Power Level	Maximum Broadband Sound Power Level	Hub Height
SWT D3 Direct Drive Wind Turbine Generator, Maximum Power rating 2300kW	2.300 MW	105 dBA	99.5m
SWT D3 Direct Drive Wind Turbine Generator, Maximum Power rating 2221kW	2.221 MW	104 dBA	99.5m

These warranted sound power levels are presented with reference to the IEC 61400-11:2002 Code with amendment 1 dated 2006-05 based on a hub height of 99.5m. Siemens has performed acoustic testing of its SWT-2.3-113 model wind turbine generator in accordance with IEC 61400-11:2002 with amendment 1 dated 2006-05 and confirms that the attached acoustic emission datasheets are consistent with that testing. An executive summary of such testing is attached hereto. Based on this testing of the SWT-2.3-113 model wind turbine generator in accordance with IEC 61400-11:2002 with amendment 1 dated 2006-05, Siemens does not expect that the tonality generated by the SWT D3 Direct Drive wind turbine generators listed above with a Maximum Power of either 2300kW or 2221kW will be higher than 3 dB when tested in accordance with the IEC 61400-11:2002 Code with amendment 1 dated 2006-05.

Best regards,

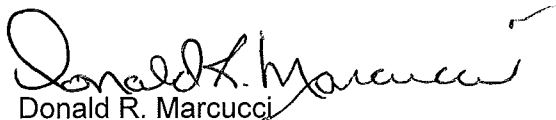

Donald R. Marcucci  
Director Project Acquisitions  
Siemens Energy, Inc.  
Wind Power Americas  
Enclosures (3)

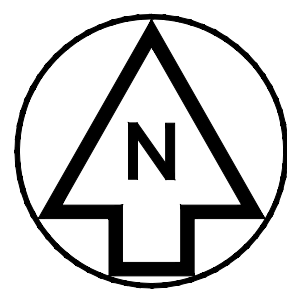

SUBSTATION TRANSFORMER  
POINT SOURCE LOCATION  
E 363269.13  
N 4891095.48

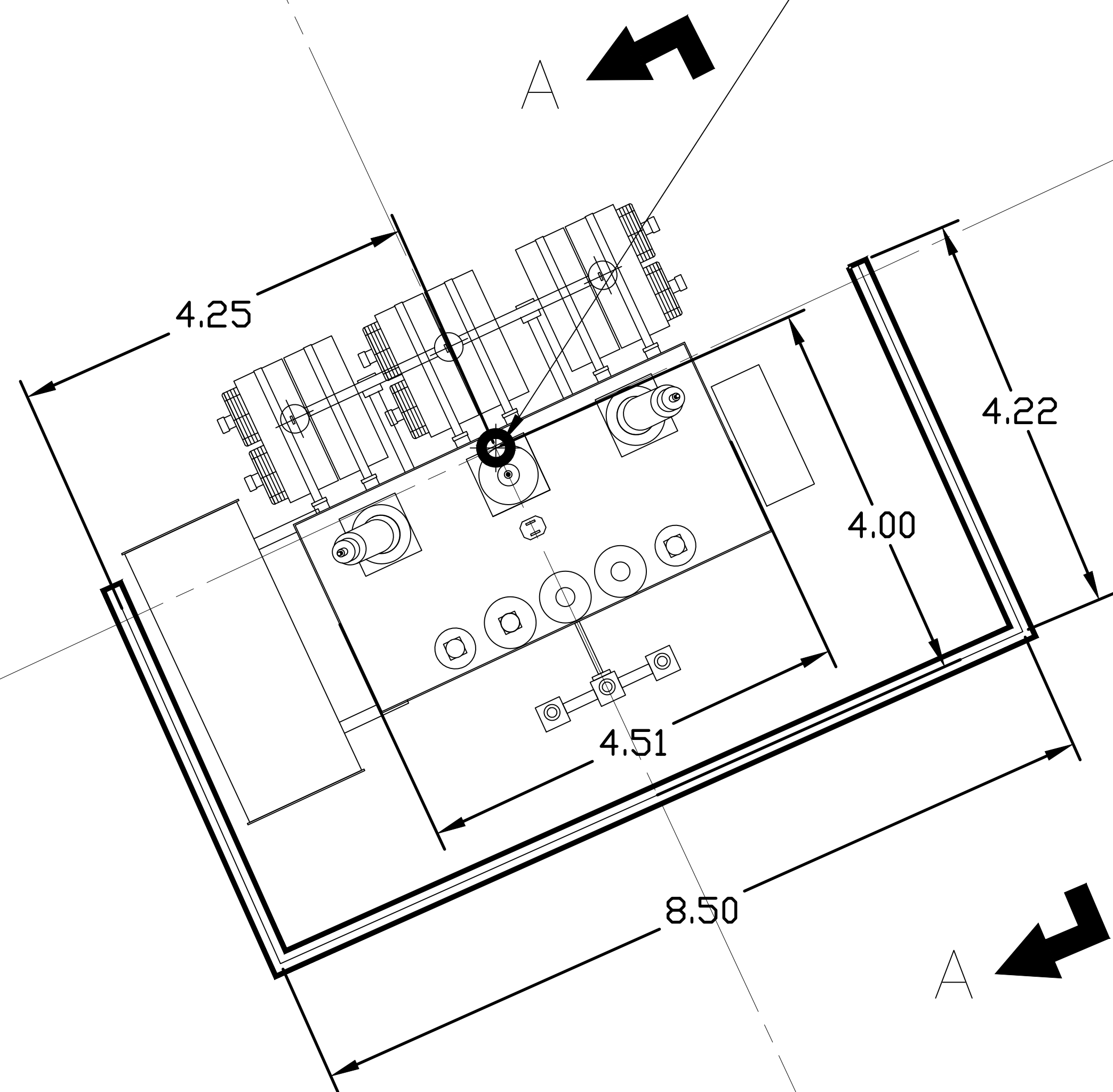

PLAN VIEW

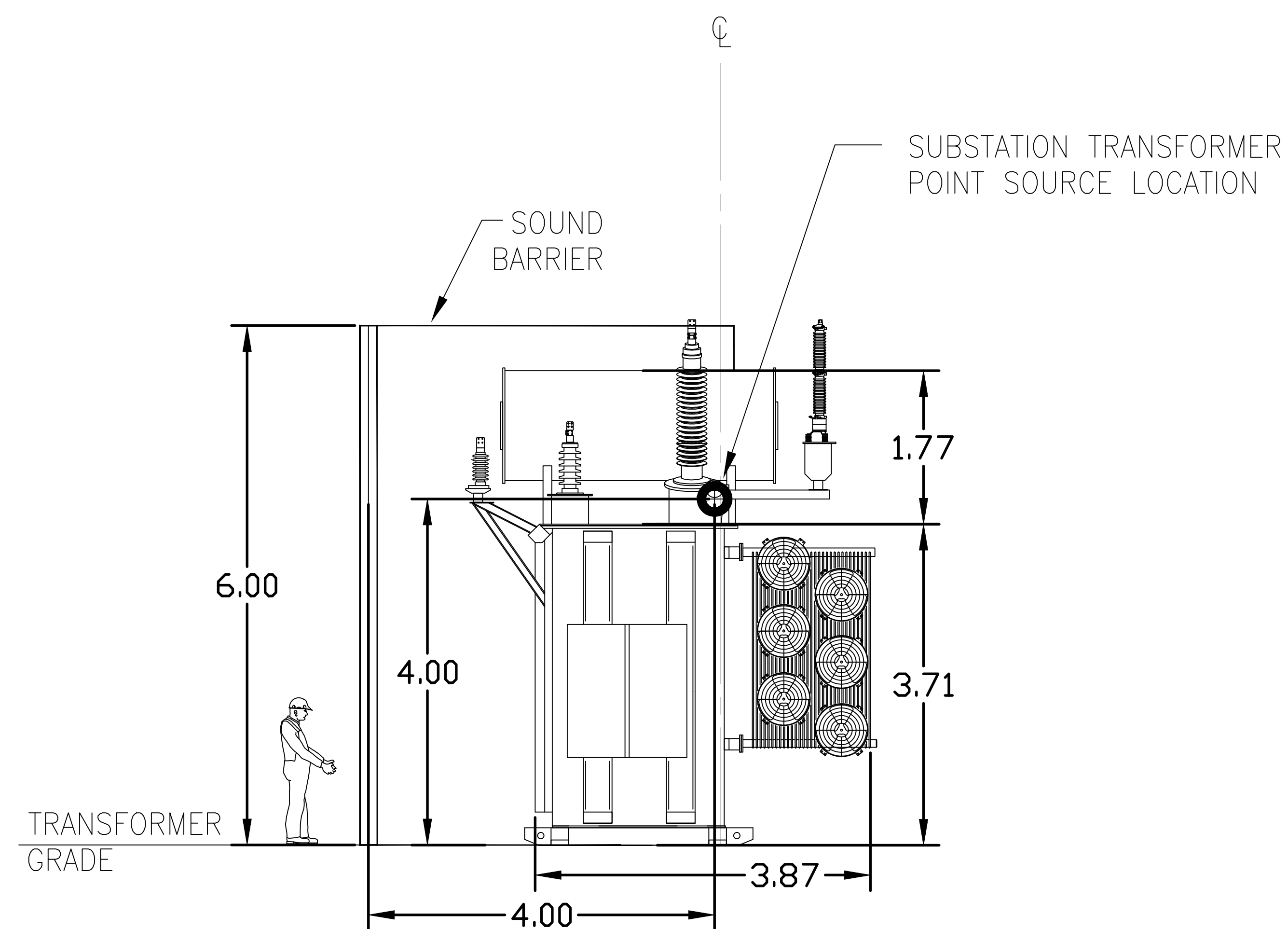

SECTION VIEW  
A-A

ALL DIMENSIONS IN METERS



**PROJECT NUMBER:** 30160-06-80467-1  
**PAGE:** 1 of 4  
**DATE:** November 6, 2006

662 Cromwell Avenue Telephone : (651) 645-3601  
Saint Paul, MN 55114 Toll Free : (888) 645-TEST  
USA Telefax : (651) 659-7348  
Website : www.twincitytesting.com

Investigative Chemistry Geotechnical Construction Materials  
Non Destructive Testing Failure Analysis Product Evaluation  
Metallurgical Analysis Materials Testing Welder Qualification

**SOUND ABSORPTION TESTING CONDUCTED ON  
COMPOSITE CONCRETE PANELS**

*(Richmond Panel- Lid Side - Natural Stone Pattern)*

**Prepared for:  
DURISOL, INC.  
Attn. Jason Scarrow  
PO Box 400  
51 Arthur Street South  
Mitchell, Ontario, Canada NOK1N0**

**Client Purchase Order Number: Verbal**

**Prepared By:**



**Mathew N. Botz  
Project Manager  
Product Testing Department  
(651) 659-7353**

**Reviewed By:**



**Kyle T. Hall  
Sr. Engineering Technician  
Product Testing Department**

**The test results contained in this report pertain only to the samples submitted for testing and not necessarily to all similar products.**

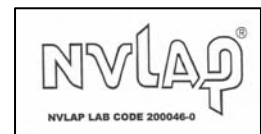

**Noise Reduction Coefficient (ASTM C423-02)**

**INTRODUCTION:**

This report presents the results of sound absorption testing conducted on concrete panels. The test unit was submitted by Mr. Jason Scarrow. This work was completed on October 20, 2006.

This report must not be reproduced except in full with the approval of Stork Twin City Testing Corporation. The data in this report relates only to the items tested.

Stork Twin City Testing Corporation has been accredited by the U.S. Department of Commerce and the National Institute of Standards and Technology (NIST, formerly NBS) under their National Voluntary Laboratory Accreditation Program (NVLAP) for conducting ASTM C423 test procedures. This report may not be used to claim product endorsement by NVLAP, NIST or any agency of the U.S. Government.

**TEST RESULTS SUMMARY:**

*Durisol Concrete Panels*

				Test Results		
Test #	Panel Identification	Exposed Surface	Weight (psf)	NRC	SAA	--
1	Richmond Panel, Natural Stone Pattern	Lid Side	37.8	0.80	0.80	--

See 'TEST DATA' section for detailed results.

**SPECIMEN DESCRIPTION:** (Also see "Test Results")

The specimens were described as concrete panels and were identified by Durisol Inc. as Richmond Panels, RDNBP, with a Natural Stone / Natural Stone pattern. Each panel measured 48" x 36-1/2" x 8" and weighed 460-lbs each (37.8-psf). A total of six (6) panels were tested, for a total of 72-ft<sup>2</sup>. The 'Lid' surface with the Natural Stone Pattern was tested. The panels were positioned in a 2x3 orientation. Side by side joints were flat butt-joints and stacked panels had tongue & groove joints.

Information and statements in this report are derived from material, information and/or specifications furnished by the client and exclude any expressed or implied warranties as to the fitness of the material tested or analyzed for any particular purpose or use. This report is the confidential property of our client and may not be used for advertising purposes. This report shall not be reproduced except in full, without written approval of this laboratory. The recording of false, fictitious or fraudulent statements or entries on this document may be punished as a felony under Federal Statutes including Federal Law Title 18, Chapter 47

PROJECT NUMBER: 30160-06-80467-1

PAGE: 3 of 4

DATE: November 6, 2006

**TEST PROCEDURE****Sound Absorption Test**

ASTM C 423-02, "Sound Absorption and Sound Absorption Coefficient by the Reverberation Room Method", was followed in every respect. The panels were tested in Type A Mounting (on the floor). The panel edge/perimeter was covered with 8" tall border walls constructed from 5/8" sheetrock

NRC was calculated by rounding the sound absorption coefficients for 250, 500, 1000 and 2000 Hz to the nearest 0.05. SAA was calculated by rounding the sound absorption coefficients for the twelve frequencies from 200 Hz to 2500 Hz to the nearest 0.01.

**TEST EQUIPMENT:**

<u>Manufacturer</u>	<u>Model</u>	<u>Description</u>	<u>S/N</u>
Norwegian Electronics	NE830	Real Time Analyzer	11511
Brüel & Kjær	3923	Rotating Microphone Boom	815424
Norsonic (Source Rm)	1230	Pressure Condenser Microphone	26361
Brüel & Kjær (Term Rm)	4192	Pressure Condenser Microphone	2360314

**REMARKS:**

The test sample will be retained for a period of **15-days** and then discarded unless notified by the client.

F:\Product\MMFILES\MNB\2006 - REPORTS

MNB\80467-Durisol-1.doc

**PROJECT NUMBER:** 30160-06-80467-1

**PAGE:** 4 of 4

**DATE:** November 6, 2006

**TEST RESULTS:**

<b>Filename</b> test 1	<b>ASTM C423 - Sound Absorption</b>				
<b>Client</b> Durisol Inc.	<b>Product</b> Richmond Panel	<b>Model #</b> RDNDP	<b>Quantity</b> 1	<b>Comment</b> Lid Side	
<b>Sample Size - Wt.</b> 108.0 in x 96.0 in x 8" - 2760 lbs	<b>Sample Description</b> Durisol Inc.: : Concrete Panel: Richmond Panel - RDNDP : Natural Stone / Natural Stone Pattern : 3' x 4' at 460-lbs each, 6 panels total :				
<b>Time Stamp</b> Fri, Oct 20, 2006 - 10:30 AM					
	<b>Total Sample Area</b> 72.0 ft <sup>2</sup>				

F (Hz)	Absorption Coefficient	Absorption (Sabins)*
100	0.16	11.53
125	0.29	21.14
160	0.26	18.73
200	0.43	30.66
250	0.53	38.49
315	0.61	43.93
400	0.78	55.85
500	0.97	69.98
630	1.11	79.60
800	1.06	76.37
1000	0.87	62.99
1250	0.73	52.27
1600	0.72	52.07
2000	0.89	64.41
2500	0.91	65.16
3150	0.89	64.29
4000	0.90	64.62
5000	0.90	65.09

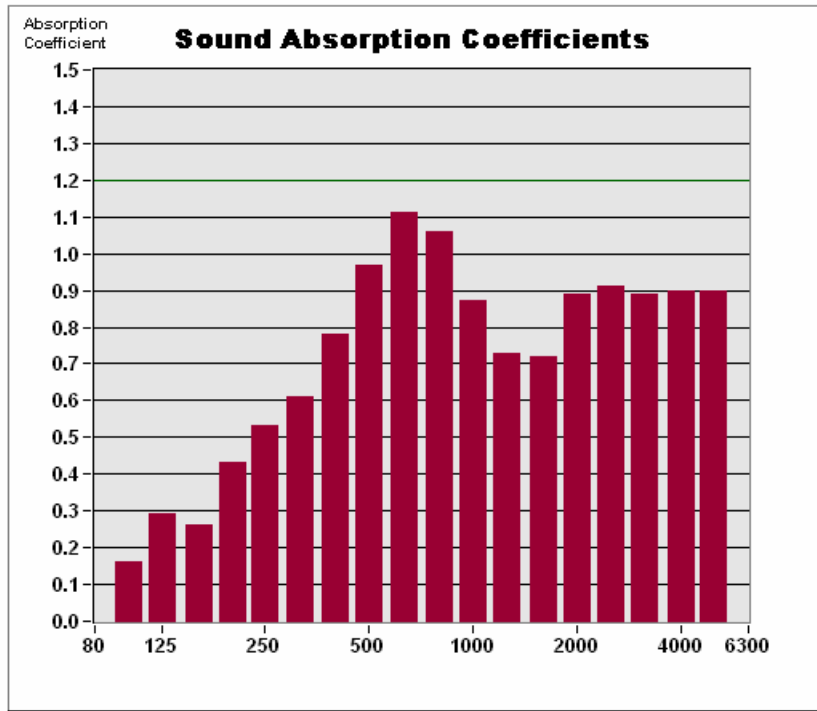

Temp (°C) **21.5**    R.H. (%) **54**    ATM (mbar) **982**

**SAA = 0.80    NRC = 0.80**

\* total absorption based on 72.0 ft<sup>2</sup>

Information and statements in this report are derived from material, information and/or specifications furnished by the client and exclude any expressed or implied warranties as to the fitness of the material tested or analyzed for any particular purpose or use. This report is the confidential property of our client and may not be used for advertising purposes. This report shall not be reproduced except in full, without written approval of this laboratory. The recording of false, fictitious or fraudulent statements or entries on this document may be punished as a felony under Federal Statutes including Federal Law Title 18, Chapter 47.

NOISE CONTROL /

# DURISOL PRECAST NOISE BARRIERS



ATTRACTIVE, SOUND-ABSORPTIVE WALLS MADE OF DURABLE, FIELD-PROVEN  
DURISOL MATERIAL

---

Armtec's Durisol precast noise barriers are made of a proprietary material consisting of organic softwood shavings processed to an acoustically engineered size and bonded together under pressure with Portland cement. Durisol is highly sound absorptive, porous, rigid, non-combustible, thermally insulating and freeze-thaw resistant.

Durisol precast noise barriers are panel and post systems. They are engineered in-house and specify the size for posts and the depth and diameter of footings. Standard steel posts or optional concrete posts can be accommodated.

Our standard systems are noise absorptive on both sides. They can also incorporate solid noise reflective or transparent elements, as well as integrated traffic barriers and retaining wall panels.

**Visual appeal**

Wide variety of architectural textures, patterns and colours

**Acoustical Characteristics**

Noise Reduction Coefficient of 0.70 or greater

**Panel and post design**

Lightweight, easy-to-install systems

**TYPICAL APPLICATIONS**

- Roads and highways
- Bridges
- Acoustic enclosures
- Residential developments

**MITCHELL SYSTEM**



Posts are spaced 3.65m apart

**Wall height**

Engineered for heights up to 6m

**Versatile**

Ideal for slope conditions, directional changes and areas with difficult site access

**Flexible**

Panels can be modified on-site for short bays

**RICHMOND SYSTEM**



Posts are spaced 4.56m apart

**Wall height**

Engineered for heights up to 11m or more

**Economical**

Fewer panels reduces on-site handling and installation costs

**OHIO SYSTEM**



Posts are spaced up to 7.3m apart

**Wall height**

Engineered for heights up to 11m or more

**Cost-effective**

Longest post spacing of the Durisol systems

**Unique**

Ideal for straight runs of wall with good site access where noise absorption is not required on the residential side

**DURISOL NOISE BARRIER/RETAINING WALL**



Combination noise barrier/retaining wall system

**Innovative design**

Noise barrier and retaining wall panels are stacked on top of each other

**Minimal space requirements**

Useful in tight spaces

**Functional**

Well-suited for areas where there are grade differences between the two sides of a barrier

## Appendix C

### Sound Pressure Levels at Points of Reception, Sound Pressure Contours from CADNA-A

**Table C.1 Noise Impact Summary – Non-Participating Project Noise Receptors (437 receptors)**

The table is sorted by noise receptors ID; “Vacant” = vacant lot noise receptor, “Existing” = existing dwelling; “Total” = combined contribution from all sources (substation and WTGs); blank cells in “Sound pressure” columns = POR at more than 5000 m from source.

Noise Receptor ID	Description	UTM NAD 83, Zone 18		Nearest source distance [m]			Sound pressure [dBA]						Limit
				WTG		Sub-station	POR at 4.5 m			POR at 1.5 within 30 m			
		X	Y	Distance	ID	Distance	Substation	WTGs	Total	Substation	WTGs	Total	
R005	Existing	359893	4890564	710	S04	3418	12.9	39.2	39.2	12.0	37.4	37.5	40.0
R007	Existing	364239	4892296	976	S06	1543	27.7	35.4	36.1	25.3	33.3	34.0	40.0
R008	Vacant	363457	4888709	780	S20	2394	16.7	39.9	40.0	15.9	38.1	38.1	40.0
R011	Existing	366872	4893632	711	S30	4406	9.1	37.1	37.1	8.3	35.3	35.3	40.0
R014	Existing	366786	4893503	617	S30	4262	13.9	38.2	38.2	11.0	36.5	36.5	40.0
R017	Vacant	358641	4888158	857	S17	5482		39.0	39.0		37.1	37.1	40.0
R018	Existing	364059	4892107	725	S06	1283	29.8	36.8	37.6	27.6	34.9	35.6	40.0
R020	Existing	362062	4886820	571	S11	4442	9.0	39.6	39.6	8.2	37.9	37.9	40.0
R021	Existing	360101	4890790	777	S04	3183	13.9	37.8	37.8	13.0	36.0	36.0	40.0
R022	Existing	362789	4891859	942	S31	902	34.2	36.0	38.2	29.3	33.9	35.2	40.0
R025	Existing	367198	4890237	722	S02	4022	9.9	38.6	38.6	6.2	36.7	36.7	40.0
R026	Existing	367812	4891038	803	S13	4544	8.6	38.6	38.6	2.9	36.6	36.6	40.0
R027	Vacant	365534	4892983	1035	S15	2949	19.4	35.2	35.4	16.6	33.2	33.3	40.0
R028	Existing	364459	4892309	984	S15	1699	26.5	35.8	36.3	24.0	33.8	34.2	40.0
R029	Existing	367962	4891160	697	S13	4693	4.7	38.9	38.9	2.5	37.0	37.0	40.0
R031	Existing	359345	4888662	719	S32	4617	8.4	39.8	39.8	7.5	37.9	37.9	40.0
R033	Existing	360714	4891207	917	S22	2557	16.9	36.5	36.6	16.0	34.3	34.4	40.0
R034	Existing	363968	4892164	745	S06	1277	29.9	36.4	37.3	27.6	34.5	35.3	40.0
R035	Existing	361623	4891803	1058	S31	1792	25.9	35.2	35.6	23.4	33.1	33.6	40.0
R036	Existing	368045	4894070	1408	S28	5626		34.2	34.2		31.9	31.9	40.0
R040	Existing	365623	4888851	766	S21	3253	9.7	39.3	39.3	5.8	37.4	37.4	40.0
R041	Existing	359946	4890749	816	S04	3341	13.2	37.8	37.8	12.3	35.9	35.9	40.0
R045	Vacant	357945	4889761	1245	S01	5489		32.8	32.8		30.7	30.7	40.0
R049	Vacant	364068	4892424	1022	S06	1550	27.6	34.6	35.4	25.3	32.5	33.2	40.0
R051	Vacant	358267	4887854	693	S17	5961		38.7	38.7		37.0	37.0	40.0
R052	Vacant	360318	4890871	800	S04	2959	14.9	37.7	37.7	14.0	35.8	35.8	40.0
R054	Vacant	365772	4893093	1199	S15	3202	18.2	35.1	35.2	15.3	33.0	33.1	40.0
R055	Vacant	359694	4890626	729	S29	3606	12.1	38.2	38.2	11.2	36.4	36.4	40.0
R056	Existing	364908	4890729	1057	S37	1679	20.9	38.3	38.3	19.9	36.1	36.2	40.0
R057	Existing	364082	4892061	695	S06	1262	30.0	37.1	37.9	27.8	35.2	35.9	40.0
R058	Existing	364563	4892351	905	S15	1803	25.8	36.1	36.5	23.2	34.0	34.4	40.0
R060	Existing	358523	4889966	770	S01	4878	7.6	36.6	36.6	6.8	34.8	34.8	40.0
R061	Existing	364298	4892572	1243	S15	1800	25.9	34.2	34.8	23.3	32.1	32.6	40.0
R065	Existing	365563	4893048	1103	S15	3012	19.1	34.9	35.0	16.2	32.8	32.9	40.0



Noise Receptor ID	Description	UTM NAD 83, Zone 18		Nearest source distance [m]			Sound pressure [dBA]						
				WTG		Sub- station	POR at 4.5 m			POR at 1.5 within 30 m			Limit
		X	Y	Distance	ID	Distance	Substation	WTGs	Total	Substation	WTGs	Total	
R066	Vacant	357961	4889769	1231	S01	5472		32.9	32.9		30.7	30.7	40.0
R067	Existing	364146	4892216	861	S06	1423	28.6	35.9	36.6	26.3	33.8	34.5	40.0
R068	Existing	364914	4890629	972	S37	1710	20.9	38.6	38.7	19.8	36.5	36.6	40.0
R069	Existing	367873	4894024	1366	S30	5456		34.3	34.3		32.1	32.1	40.0
R070	Existing	357913	4889708	1269	S01	5533		32.7	32.7		30.5	30.5	40.0
R073	Vacant	364649	4892459	885	S15	1940	24.9	35.9	36.3	22.3	34.0	34.3	40.0
R074	Existing	369960	4893872	1145	S28	7244		34.2	34.2		32.3	32.3	40.0
R077	Vacant	367001	4889892	702	S02	3921	9.6	38.3	38.3	7.3	36.5	36.5	40.0
R078	Existing	360762	4891155	848	S22	2508	17.2	37.1	37.1	16.3	34.9	34.9	40.0
R079	Existing	359604	4890575	668	S29	3702	11.8	38.5	38.5	10.8	36.7	36.8	40.0
R080	Existing	362200	4887075	575	S11	4160	10.0	39.7	39.7	9.1	38.0	38.0	40.0
R081	Vacant	360150	4890764	735	S04	3137	14.1	38.2	38.2	13.2	36.3	36.4	40.0
R082	Vacant	363883	4892346	903	S06	1393	28.9	35.1	36.0	26.6	33.0	33.9	40.0
R083	Existing	365430	4893185	1226	S15	3006	19.1	34.0	34.1	16.3	31.8	31.9	40.0
R084	Vacant	361772	4892151	1260	S31	1832	25.6	33.2	33.9	23.1	31.1	31.7	40.0
R085	Existing	360668	4891181	939	S22	2602	16.7	36.5	36.6	15.8	34.3	34.4	40.0
R087	Existing	364076	4892451	1050	S06	1577	27.4	34.5	35.3	25.0	32.3	33.1	40.0
R088	Vacant	360378	4885827	1399	S09	6010		34.0	34.0		31.8	31.8	40.0
R089	Vacant	357464	4887281	1221	S17	6946		33.1	33.1		31.1	31.1	40.0
R090	Existing	358709	4890096	715	S01	4668	8.2	37.6	37.6	7.5	35.8	35.8	40.0
R091	Existing	366966	4889848	709	S02	3902	9.8	38.3	38.3	7.5	36.4	36.5	40.0
R092	Existing	368778	4894417	1327	S28	6432		32.8	32.8		30.7	30.7	40.0
R093	Existing	359060	4888604	791	S32	4891	7.5	39.1	39.1	0.8	37.2	37.2	40.0
R094	Existing	367581	4893976	1168	S30	5185		34.6	34.6		32.4	32.4	40.0
R096	Existing	362996	4891908	875	S06	857	34.7	36.1	38.5	32.6	34.1	36.4	40.0
R097	Existing	368666	4894336	1281	S28	6295		33.3	33.3		31.2	31.2	40.0
R098	Existing	359161	4890353	598	S29	4175	10.0	39.1	39.1	9.1	37.4	37.4	40.0
R099	Existing	368290	4891445	620	S13	5033		39.3	39.3		37.5	37.5	40.0
R100	Existing	357760	4889636	1414	S01	5699		31.9	31.9		29.7	29.7	40.0
R101	Existing	361821	4891454	673	S31	1491	28.1	38.4	38.8	25.6	36.5	36.8	40.0
R103	Existing	363864	4892163	719	S06	1222	30.4	36.5	37.5	28.1	34.7	35.6	40.0
R104	Existing	364124	4892384	1005	S06	1546	27.7	34.9	35.6	25.3	32.8	33.5	40.0
R105	Existing	367259	4890334	771	S02	4062	8.9	38.5	38.5	5.9	36.6	36.6	40.0
R107	Existing	363640	4888526	957	S36	2596	15.8	38.8	38.8	15.0	36.7	36.7	40.0
R109	Existing	362949	4888140	792	S05	2972	14.5	39.0	39.0	13.6	37.1	37.1	40.0
R112	Vacant	365595	4893202	1260	S15	3138	14.1	34.2	34.3	13.3	31.9	31.9	40.0
R113	Existing	364528	4892413	965	S15	1822	25.7	35.6	36.0	23.1	33.6	33.9	40.0
R114	Existing	366256	4889386	833	S27	3441	9.1	39.1	39.1	6.2	37.3	37.3	40.0
R118	Existing	367227	4893765	845	S30	4774	12.1	36.2	36.2	9.2	34.3	34.3	40.0
R120	Vacant	364131	4892300	930	S06	1481	28.2	35.4	36.1	25.8	33.3	34.0	40.0

Noise Receptor ID	Description	UTM NAD 83, Zone 18		Nearest source distance [m]			Sound pressure [dBA]						
				WTG		Sub- station	POR at 4.5 m			POR at 1.5 within 30 m			Limit
		X	Y	Distance	ID	Distance	Substation	WTGs	Total	Substation	WTGs	Total	
R122	Existing	363067	4891931	828	S06	860	34.7	36.2	38.5	32.3	34.0	36.2	40.0
R123	Vacant	358576	4890039	770	S01	4810	7.8	36.8	36.8	7.0	34.9	34.9	40.0
R124	Existing	364014	4892185	779	S06	1320	29.5	36.2	37.1	27.2	34.3	35.1	40.0
R125	Existing	369190	4893990	869	S28	6591		36.2	36.2		34.4	34.4	40.0
R126	Existing	360677	4891064	871	S22	2592	16.7	37.3	37.3	15.8	35.3	35.4	40.0
R127	Existing	363902	4889092	977	S36	2101	17.9	39.5	39.5	17.0	37.3	37.4	40.0
R128	Existing	366068	4889271	813	S37	3341	7.7	39.4	39.4	6.6	37.5	37.5	40.0
R130	Existing	366563	4889572	804	S02	3629	10.1	38.8	38.8	9.2	36.9	36.9	40.0
R131	Existing	366560	4893285	590	S30	3953	10.8	38.6	38.7	9.8	36.9	37.0	40.0
R132	Existing	364448	4892350	1010	S15	1721	26.4	35.6	36.1	23.8	33.5	34.0	40.0
R137	Existing	364030	4892155	757	S06	1304	29.6	36.4	37.3	27.4	34.5	35.3	40.0
R138	Existing	359899	4890759	851	S04	3387	13.0	37.6	37.6	12.2	35.7	35.7	40.0
R142	Existing	364168	4889387	794	S21	1930	18.7	39.7	39.8	10.3	37.6	37.6	40.0
R143	Vacant	367172	4893575	648	S30	4624	12.6	38.1	38.1	9.7	36.4	36.4	40.0
R145	Existing	364482	4890164	867	S19	1529	21.2	38.8	38.9	20.0	36.8	36.9	40.0
R149	Vacant	361532	4886274	938	S11	5125		37.1	37.1		35.1	35.1	40.0
R150	Vacant	366698	4889682	722	S02	3709	10.0	38.8	38.8	9.1	37.0	37.0	40.0
R151	Vacant	368981	4893971	851	S28	6395		36.5	36.5		34.7	34.7	40.0
R153	Vacant	368674	4893985	954	S28	6128		35.8	35.8		33.9	33.9	40.0
R157	Existing	360805	4891182	830	S22	2465	17.4	37.1	37.1	16.5	35.0	35.0	40.0
R159	Existing	358305	4889843	915	S01	5120		35.2	35.2		33.2	33.2	40.0
R160	Existing	366960	4889781	756	S02	3918	9.8	37.9	37.9	5.1	36.0	36.0	40.0
R161	Existing	364165	4892220	874	S06	1438	28.5	35.8	36.6	26.2	33.8	34.5	40.0
R162	Existing	357982	4889754	1207	S01	5455		33.1	33.1		30.9	30.9	40.0
R164	Existing	361050	4891333	785	S22	2232	18.7	37.1	37.2	17.8	35.3	35.4	40.0
R165	Existing	359814	4890699	829	S29	3478	12.7	37.8	37.9	11.8	36.0	36.0	40.0
R166	Existing	363313	4890643	742	S34	455	30.7	39.0	39.6	30.1	36.8	37.6	40.0
R167	Existing	359113	4888625	779	S32	4835	7.6	39.3	39.3	0.8	37.3	37.3	40.0
R168	Existing	361769	4886562	656	S11	4775	7.9	39.0	39.0	7.1	37.2	37.2	40.0
R169	Existing	364759	4892564	865	S15	2092	24.0	35.9	36.2	21.3	34.0	34.2	40.0
R171	Existing	364080	4892096	724	S06	1288	29.8	36.8	37.6	27.6	34.9	35.6	40.0
R172	Existing	364572	4892441	940	S15	1873	25.4	35.7	36.1	22.7	33.6	34.0	40.0
R173	Existing	364889	4890554	930	S37	1708	21.0	38.8	38.9	19.9	36.8	36.9	40.0
R175	Vacant	367980	4894001	1413	S28	5534		34.5	34.5		32.3	32.3	40.0
R176	Vacant	369874	4893890	1093	S28	7171		34.6	34.6		32.7	32.7	40.0
R178	Existing	364284	4892521	1196	S06	1750	26.2	34.4	35.0	23.7	32.3	32.8	40.0
R180	Vacant	366000	4889211	814	S37	3318	7.3	39.3	39.3	6.1	37.4	37.4	40.0
R182	Existing	360558	4890989	925	S04	2713	16.1	37.4	37.4	15.2	35.4	35.4	40.0
R184	Vacant	370001	4892471	744	S33	6871		37.8	37.8		36.2	36.2	40.0
R185	Vacant	358849	4890145	676	S01	4521	8.7	38.5	38.5	8.0	36.8	36.8	40.0

Noise Receptor ID	Description	UTM NAD 83, Zone 18		Nearest source distance [m]			Sound pressure [dBA]						
				WTG		Sub- station	POR at 4.5 m			POR at 1.5 within 30 m			Limit
		X	Y	Distance	ID	Distance	Substation	WTGs	Total	Substation	WTGs	Total	
R186	Vacant	358699	4890036	678	S01	4691	8.2	37.9	37.9	7.4	36.2	36.2	40.0
R190	Existing	365881	4893230	1194	S30	3373	17.5	34.8	34.9	12.3	32.6	32.6	40.0
R192	Existing	366628	4889597	788	S02	3678	10.0	38.6	38.6	9.1	36.7	36.7	40.0
R193	Existing	360787	4891238	880	S22	2487	17.3	36.6	36.7	16.4	34.5	34.6	40.0
R194	Existing	366226	4893109	831	S30	3577	12.3	36.9	36.9	11.3	34.9	34.9	40.0
R197	Existing	368995	4891793	734	S12	5768		38.7	38.7		36.9	36.9	40.0
R198	Existing	363999	4892125	718	S06	1262	30.0	36.7	37.6	27.8	34.8	35.6	40.0
R199	Existing	363909	4892311	873	S06	1374	29.1	35.3	36.2	26.7	33.3	34.2	40.0
R201	Existing	357805	4889647	1371	S01	5653		32.2	32.2		29.9	29.9	40.0
R202	Existing	367665	4894018	1246	S30	5278		34.3	34.3		32.1	32.1	40.0
R203	Existing	360989	4886500	604	S09	5130		39.7	39.7		38.0	38.0	40.0
R204	Existing	360702	4885983	1148	S09	5721		35.1	35.1		33.0	33.0	40.0
R205	Vacant	358654	4890060	727	S01	4730	8.0	37.3	37.3	7.3	35.5	35.5	40.0
R208	Existing	364074	4892408	1009	S06	1540	27.7	34.7	35.5	25.3	32.6	33.3	40.0
R213	Vacant	362172	4886997	570	S11	4243	9.7	39.7	39.7	8.8	38.0	38.0	40.0
R215	Vacant	363116	4888322	717	S05	2778	15.2	39.6	39.6	14.4	37.7	37.8	40.0
R216	Vacant	360447	4885766	1429	S09	6030		33.7	33.7		31.5	31.5	40.0
R219	Vacant	359279	4888645	723	S32	4682	8.1	39.7	39.7	7.3	37.8	37.8	40.0
R220	Vacant	365110	4892816	898	S15	2520	21.5	35.6	35.7	18.8	33.6	33.8	40.0
R222	Existing	359277	4890416	581	S29	4050	10.4	39.1	39.2	9.6	37.5	37.5	40.0
R226	Vacant	365709	4893089	1176	S15	3151	18.4	35.0	35.1	15.6	32.9	32.9	40.0
R227	Existing	365574	4888708	768	S21	3318	9.6	38.8	38.8	5.9	36.9	37.0	40.0
R229	Existing	363988	4892236	819	S06	1348	29.3	35.8	36.7	27.0	33.9	34.7	40.0
R230	Existing	364061	4892209	819	S06	1367	29.1	36.0	36.8	26.8	34.0	34.7	40.0
R231	Existing	362126	4891540	556	S31	1227	30.3	38.9	39.5	25.1	37.3	37.5	40.0
R232	Existing	364063	4892147	763	S06	1317	29.5	36.4	37.2	27.3	34.5	35.2	40.0
R233	Existing	358904	4888447	789	S32	5106		39.0	39.0		37.1	37.1	40.0
R235	Vacant	365888	4889147	806	S37	3265	7.1	39.5	39.5	5.8	37.6	37.6	40.0
R237	Existing	364222	4892513	1162	S06	1708	26.5	34.4	35.0	24.0	32.2	32.8	40.0
R238	Existing	364680	4892516	893	S15	2002	24.5	35.8	36.1	21.9	33.8	34.1	40.0
R239	Existing	366019	4889228	813	S37	3324	7.4	39.3	39.3	6.2	37.5	37.5	40.0
R244	Existing	360730	4891215	910	S22	2542	17.0	36.5	36.6	16.1	34.3	34.4	40.0
R245	Existing	365893	4893153	1166	S30	3334	13.3	35.2	35.2	12.3	32.9	33.0	40.0
R246	Existing	366902	4889729	765	S02	3881	9.8	38.0	38.0	5.1	36.1	36.1	40.0
R247	Existing	360436	4890915	839	S04	2839	15.5	37.6	37.6	14.6	35.6	35.7	40.0
R249	Vacant	362069	4885844	1428	S11	5387		33.0	33.0		30.8	30.8	40.0
R251	Vacant	366186	4889351	839	S27	3399	8.8	39.3	39.3	6.5	37.4	37.4	40.0
R253	Vacant	366368	4889475	809	S27	3497	10.1	39.1	39.1	5.9	37.3	37.3	40.0
R256	Vacant	368821	4891649	886	S12	5580		37.9	37.9		36.0	36.0	40.0
R259	Vacant	360151	4890808	775	S04	3132	14.2	37.8	37.8	13.2	35.9	36.0	40.0

Noise Receptor ID	Description	UTM NAD 83, Zone 18		Nearest source distance [m]			Sound pressure [dBA]						
				WTG		Sub- station	POR at 4.5 m			POR at 1.5 within 30 m			Limit
		X	Y	Distance	ID	Distance	Substation	WTGs	Total	Substation	WTGs	Total	
R261	Existing	364674	4890296	851	S19	1617	21.0	39.1	39.1	19.9	37.1	37.1	40.0
R263	Existing	364092	4892390	999	S06	1534	27.8	34.8	35.6	25.4	32.7	33.5	40.0
R264	Existing	364356	4892322	1062	S06	1639	27.0	35.5	36.1	24.4	33.4	33.9	40.0
R265	Existing	368058	4891269	622	S13	4792	4.7	39.4	39.4	2.7	37.6	37.6	40.0
R266	Existing	368149	4894137	1381	S28	5750		33.9	33.9		31.7	31.7	40.0
R267	Existing	365616	4893060	1125	S15	3060	18.9	35.0	35.1	16.0	32.8	32.9	40.0
R268	Existing	358467	4889930	801	S01	4942	7.4	36.3	36.3	6.6	34.4	34.4	40.0
R270	Existing	358452	4887973	710	S17	5740		39.1	39.1		37.4	37.4	40.0
R271	Existing	360734	4891167	877	S22	2536	17.0	36.9	36.9	16.1	34.7	34.7	40.0
R272	Existing	364271	4892333	1024	S06	1592	27.3	35.3	35.9	24.9	33.2	33.8	40.0
R273	Existing	364132	4892204	844	S06	1404	28.8	36.0	36.7	26.4	33.9	34.7	40.0
R274	Existing	363976	4892355	930	S06	1444	28.5	35.0	35.9	26.1	33.0	33.8	40.0
R275	Existing	361386	4891597	943	S22	1949	24.9	36.1	36.4	19.5	34.1	34.3	40.0
R276	Existing	365906	4893126	1149	S30	3328	13.3	35.4	35.4	12.5	33.1	33.1	40.0
R278	Existing	366657	4889616	775	S02	3697	10.0	38.6	38.6	9.1	36.7	36.7	40.0
R280	Existing	364392	4890113	902	S19	1492	21.2	38.8	38.8	20.1	36.6	36.7	40.0
R282	Vacant	360437	4885826	1377	S09	5982		34.0	34.0		31.9	31.9	40.0
R283	Existing	362698	4891900	942	S31	987	28.8	35.7	36.5	28.3	33.3	34.5	40.0
R284	Vacant	361792	4892073	1181	S31	1771	26.0	33.7	34.4	23.6	31.6	32.2	40.0
R287	Vacant	366449	4893198	644	S30	3812	11.3	38.2	38.2	10.4	36.4	36.4	40.0
R288	Vacant	360601	4890918	864	S04	2674	16.3	37.9	38.0	15.4	36.0	36.1	40.0
R289	Vacant	366325	4893068	726	S30	3637	12.0	37.7	37.7	11.0	35.8	35.8	40.0
R291	Existing	363359	4888447	816	S05	2650	15.7	39.2	39.2	14.8	37.3	37.3	40.0
R292	Existing	359462	4890503	602	S29	3853	11.2	39.0	39.0	10.2	37.3	37.3	40.0
R293	Existing	366725	4893495	637	S30	4207	9.8	37.9	37.9	9.0	36.2	36.2	40.0
R294	Vacant	360012	4890761	791	S04	3274	13.5	37.8	37.8	12.6	36.0	36.0	40.0
R295	Vacant	367768	4890950	892	S13	4501	8.8	38.3	38.3	3.9	36.3	36.3	40.0
R298	Existing	364002	4892399	980	S06	1495	28.1	34.7	35.6	25.7	32.7	33.5	40.0
R300	Existing	359452	4888735	772	S32	4488	8.8	39.7	39.7	7.9	37.7	37.7	40.0
R301	Existing	360046	4890779	790	S04	3239	13.7	37.8	37.8	12.8	35.9	35.9	40.0
R305	Existing	366313	4889429	820	S27	3470	10.1	39.1	39.1	6.2	37.3	37.3	40.0
R306	Existing	369559	4893778	802	S28	6838		37.2	37.2		35.5	35.5	40.0
R307	Existing	360208	4890842	792	S04	3071	14.4	37.6	37.7	13.5	35.8	35.8	40.0
R308	Existing	360481	4889210	870	S04	3366	12.8	39.7	39.7	12.0	37.6	37.6	40.0
R309	Existing	360738	4891222	908	S22	2534	17.0	36.5	36.5	16.2	34.3	34.4	40.0
R311	Existing	363960	4892107	687	S06	1225	30.4	37.0	37.8	28.2	35.1	35.9	40.0
R312	Existing	364228	4892321	993	S06	1556	27.6	35.3	36.0	25.2	33.2	33.8	40.0
R314	Existing	358234	4889849	984	S01	5187		34.6	34.6		32.6	32.6	40.0
R315	Existing	369384	4893953	876	S28	6749		36.2	36.2		34.4	34.4	40.0
R316	Existing	358861	4890030	571	S01	4535	8.7	39.5	39.5	7.9	37.9	37.9	40.0

Noise Receptor ID	Description	UTM NAD 83, Zone 18		Nearest source distance [m]			Sound pressure [dBA]						
				WTG		Sub- station	POR at 4.5 m			POR at 1.5 within 30 m			Limit
		X	Y	Distance	ID	Distance	Substation	WTGs	Total	Substation	WTGs	Total	
R321	Vacant	364300	4892531	1212	S06	1767	26.1	34.4	35.0	23.6	32.2	32.8	40.0
R322	Existing	365833	4889090	834	S37	3256	7.2	39.4	39.4	5.9	37.5	37.5	40.0
R323	Vacant	366808	4889767	684	S02	3780	10.0	38.8	38.8	9.2	37.0	37.0	40.0
R324	Vacant	362433	4891633	611	S31	994	32.8	38.1	39.3	30.7	36.4	37.4	40.0
R326	Vacant	360840	4891142	778	S22	2430	17.6	37.5	37.6	16.7	35.7	35.7	40.0
R327	Vacant	367547	4890730	868	S14	4293	5.5	38.3	38.3	4.7	36.4	36.4	40.0
R330	Vacant	364585	4892408	912	S15	1858	25.5	35.9	36.3	22.8	33.9	34.2	40.0
R331	Vacant	365802	4893036	1156	S15	3191	18.3	35.5	35.5	12.9	33.3	33.4	40.0
R332	Vacant	360897	4891167	751	S22	2373	17.9	37.7	37.7	17.0	35.8	35.9	40.0
R333	Existing	362146	4891676	677	S31	1264	25.5	37.2	37.5	24.7	35.3	35.7	40.0
R334	Existing	364084	4892284	897	S06	1441	28.5	35.5	36.3	26.1	33.4	34.2	40.0
R335	Existing	367376	4893735	863	S30	4882	11.7	36.4	36.4	8.9	34.4	34.4	40.0
R336	Existing	364175	4892438	1075	S06	1620	27.1	34.7	35.4	24.7	32.5	33.2	40.0
R338	Existing	361116	4886227	892	S09	5323		37.1	37.1		35.1	35.1	40.0
R339	Existing	366644	4893340	561	S30	4053	10.4	38.9	38.9	9.5	37.3	37.3	40.0
R340	Existing	364514	4892388	966	S15	1795	25.9	35.7	36.1	23.3	33.6	34.0	40.0
R341	Existing	364097	4892228	850	S06	1403	28.8	35.8	36.6	26.5	33.8	34.5	40.0
R342	Existing	368512	4891540	762	S13	5262		38.5	38.5		36.5	36.5	40.0
R343	Existing	364162	4892263	910	S06	1469	28.3	35.6	36.3	25.9	33.5	34.2	40.0
R344	Existing	364542	4892328	915	S15	1772	26.0	36.1	36.5	23.4	34.0	34.4	40.0
R345	Existing	364254	4892556	1215	S06	1762	26.1	34.2	34.8	23.6	32.0	32.6	40.0
R347	Existing	357871	4889681	1308	S01	5581		32.5	32.5		30.3	30.3	40.0
R348	Existing	360487	4890950	877	S04	2786	15.8	37.4	37.5	14.8	35.5	35.5	40.0
R349	Existing	363772	4888688	867	S36	2460	16.4	39.1	39.1	15.5	37.0	37.0	40.0
R350	Existing	366311	4893115	750	S30	3651	12.0	37.4	37.4	11.0	35.5	35.5	40.0
R351	Vacant	366775	4889715	717	S02	3768	9.9	38.6	38.6	9.1	36.8	36.8	40.0
R352	Vacant	369763	4892264	689	S33	6598		39.0	39.0		37.3	37.3	40.0
R353	Existing	359505	4890524	618	S29	3807	11.3	38.8	38.8	10.4	37.1	37.1	40.0
R354	Vacant	364781	4890839	1206	S06	1533	21.6	37.7	37.8	20.5	35.5	35.7	40.0
R355	Vacant	362901	4891871	940	S06	859	34.7	36.1	38.5	32.8	34.0	36.5	40.0
R356	Vacant	362602	4887414	984	S11	3741	11.5	37.4	37.4	10.6	35.3	35.3	40.0
R357	Vacant	366748	4889709	712	S02	3745	10.0	38.8	38.8	9.1	36.9	36.9	40.0
R360	Vacant	360396	4890844	768	S04	2884	15.3	38.0	38.0	14.3	36.2	36.2	40.0
R362	Vacant	369716	4892234	686	S33	6547		39.1	39.1		37.5	37.5	40.0
R364	Existing	358796	4888349	828	S32	5249		38.9	38.9		37.0	37.0	40.0
R365	Vacant	360797	4891118	798	S22	2472	17.4	37.5	37.5	16.4	35.6	35.6	40.0
R369	Existing	360965	4890937	558	S22	2310	22.7	39.9	40.0	20.1	38.3	38.4	40.0
R370	Existing	364908	4892724	897	S15	2310	22.7	35.5	35.8	20.0	33.6	33.8	40.0
R374	Existing	369808	4893889	1046	S28	7111		35.0	35.0		33.1	33.1	40.0
R375	Existing	357788	4889639	1387	S01	5671		32.1	32.1		29.9	29.9	40.0

Noise Receptor ID	Description	UTM NAD 83, Zone 18		Nearest source distance [m]			Sound pressure [dBA]						
				WTG		Sub- station	POR at 4.5 m			POR at 1.5 within 30 m			Limit
		X	Y	Distance	ID	Distance	Substation	WTGs	Total	Substation	WTGs	Total	
R378	Existing	364102	4892355	969	S06	1510	28.0	35.0	35.8	25.6	32.9	33.7	40.0
R379	Existing	364062	4892364	964	S06	1495	28.1	35.0	35.8	25.7	32.9	33.7	40.0
R380	Existing	362677	4891770	813	S31	897	34.2	36.6	38.6	32.3	34.6	36.6	40.0
R381	Existing	364083	4892222	839	S06	1390	28.9	35.9	36.7	26.6	33.9	34.6	40.0
R386	Existing	364270	4890005	947	S19	1480	21.1	38.8	38.9	20.0	36.7	36.8	40.0
R387	Existing	366670	4893402	591	S30	4109	10.2	38.5	38.5	9.3	36.8	36.8	40.0
R389	Vacant	361023	4891249	729	S22	2252	23.0	37.7	37.8	17.7	35.9	36.0	40.0
R390	Vacant	364033	4889676	743	S34	1612	20.2	39.5	39.5	19.3	37.4	37.4	40.0
R393	Vacant	368197	4894190	1388	S28	5819		33.6	33.6		31.5	31.5	40.0
R394	Existing	359641	4890604	699	S29	3661	11.9	38.3	38.3	11.0	36.5	36.5	40.0
R396	Existing	361426	4891626	970	S22	1918	25.1	36.0	36.3	19.6	34.0	34.1	40.0
R401	Vacant	366899	4893486	564	S30	4346	13.6	38.9	38.9	10.7	37.3	37.3	40.0
R402	Existing	363945	4892249	820	S06	1336	29.4	35.8	36.7	27.1	33.8	34.6	40.0
R403	Existing	364660	4892504	902	S15	1979	24.7	35.8	36.1	22.0	33.8	34.1	40.0
R404	Existing	365210	4893014	1067	S15	2729	20.5	34.5	34.7	17.7	32.4	32.5	40.0
R405	Existing	362809	4886297	1480	S11	4820	7.7	32.9	32.9	7.0	30.6	30.7	40.0
R407	Existing	360590	4891007	926	S22	2681	16.3	37.3	37.4	15.4	35.4	35.4	40.0
R408	Existing	364184	4892238	899	S06	1464	28.3	35.8	36.5	25.9	33.7	34.4	40.0
R409	Existing	364214	4892234	911	S06	1480	28.2	35.8	36.5	25.8	33.7	34.4	40.0
R411	Existing	362360	4892437	1408	S31	1620	27.1	32.4	33.5	24.7	30.2	31.3	40.0
R412	Existing	367587	4890848	855	S14	4325	9.4	38.6	38.7	4.1	36.7	36.7	40.0
R414	Existing	357207	4887086	1494	S17	7268		31.3	31.3		29.1	29.1	40.0
R415	Existing	360594	4891137	980	S22	2676	16.3	36.5	36.6	15.4	34.4	34.5	40.0
R416	Existing	362577	4891721	731	S31	933	33.8	37.1	38.8	31.7	35.2	36.8	40.0
R417	Existing	362565	4887449	956	S11	3713	11.6	37.7	37.7	10.7	35.6	35.6	40.0
R418	Existing	364078	4892326	934	S06	1472	28.2	35.2	36.0	25.9	33.1	33.9	40.0
R420	Existing	368977	4891757	770	S12	5746		38.4	38.4		36.5	36.5	40.0
R421	Existing	361093	4891340	770	S22	2189	18.9	37.3	37.3	18.0	35.4	35.5	40.0
R422	Existing	368133	4894055	1334	S28	5693		34.3	34.3		32.2	32.2	40.0
R425	Existing	369291	4893952	849	S28	6665		36.4	36.4		34.7	34.7	40.0
R428	Existing	364219	4892470	1121	S06	1670	26.8	34.6	35.2	24.3	32.4	33.0	40.0
R430	Vacant	359558	4890551	642	S29	3751	11.6	38.7	38.7	10.6	36.9	36.9	40.0
R431	Existing	366520	4893262	611	S30	3906	11.0	38.4	38.5	10.0	36.7	36.7	40.0
R433	Vacant	361494	4891408	754	S22	1803	25.8	37.9	38.1	23.2	36.0	36.3	40.0
R436	Existing	362930	4891822	893	S06	802	35.4	36.4	39.0	33.5	34.4	37.0	40.0
R439	Existing	365949	4889171	817	S37	3299	7.1	39.3	39.3	5.8	37.4	37.4	40.0
R440	Vacant	367787	4893861	1185	S30	5297		35.2	35.2		33.1	33.1	40.0
R442	Existing	364265	4892287	983	S06	1553	27.6	35.5	36.2	25.2	33.4	34.0	40.0
R443	Existing	364378	4892243	1012	S06	1595	27.3	35.9	36.5	24.9	33.8	34.3	40.0
R444	Existing	364258	4892501	1166	S06	1718	26.4	34.5	35.1	23.9	32.3	32.9	40.0

Noise Receptor ID	Description	UTM NAD 83, Zone 18		Nearest source distance [m]			Sound pressure [dBA]						
				WTG		Sub- station	POR at 4.5 m			POR at 1.5 within 30 m			Limit
		X	Y	Distance	ID	Distance	Substation	WTGs	Total	Substation	WTGs	Total	
R447	Existing	360700	4891163	903	S22	2570	16.8	36.8	36.8	15.9	34.5	34.6	40.0
R450	Existing	367116	4890118	676	S02	3969	7.3	38.7	38.7	6.4	36.9	36.9	40.0
R452	Existing	364340	4892217	968	S06	1550	27.6	35.9	36.5	25.2	33.8	34.4	40.0
R454	Existing	368019	4891231	644	S13	4752	4.7	39.2	39.2	1.7	37.4	37.4	40.0
R459	Existing	367339	4893889	995	S30	4936	7.4	34.3	34.3	6.6	32.5	32.5	40.0
R460	Existing	358748	4890166	747	S01	4616	8.4	37.5	37.5	7.7	35.7	35.7	40.0
R462	Vacant	360797	4891042	755	S22	2472	21.8	38.0	38.1	16.4	36.1	36.2	40.0
R464	Vacant	367916	4891122	726	S13	4647	8.3	38.8	38.8	2.7	36.9	36.9	40.0
R466	Existing	361721	4886415	794	S11	4930	7.4	37.8	37.8	6.6	35.9	35.9	40.0
R467	Existing	363656	4888940	822	S20	2190	17.6	39.7	39.8	16.7	37.7	37.8	40.0
R468	Existing	360663	4891152	928	S22	2607	16.7	36.7	36.7	15.7	34.5	34.5	40.0
R470	Vacant	366861	4893464	553	S30	4303	13.8	39.0	39.0	10.8	37.4	37.4	40.0
R473	Vacant	360111	4889023	1042	S29	3777	11.3	39.5	39.5	10.4	37.3	37.3	40.0
R474	Existing	359973	4890759	810	S04	3314	13.4	37.7	37.8	12.5	35.9	35.9	40.0
R476	Existing	362890	4887884	1021	S05	3234	13.4	37.8	37.8	12.6	35.7	35.7	40.0
R477	Existing	366920	4893657	726	S30	4460	13.2	37.0	37.0	8.2	35.1	35.2	40.0
R478	Existing	360615	4891158	972	S22	2655	16.4	36.5	36.5	15.4	34.3	34.4	40.0
R479	Existing	360802	4891262	885	S22	2473	17.4	36.5	36.6	16.4	34.4	34.5	40.0
R480	Existing	359029	4890238	626	S29	4326	9.4	39.2	39.2	8.6	37.5	37.5	40.0
R481	Existing	367777	4893927	1231	S30	5323		34.8	34.8		32.7	32.7	40.0
R483	Existing	360249	4889075	1014	S04	3634	11.8	39.5	39.5	10.9	37.3	37.4	40.0
R485	Existing	364070	4892182	798	S06	1350	29.3	36.2	37.0	27.0	34.2	34.9	40.0
R486	Existing	363949	4892360	929	S06	1436	28.5	35.0	35.9	26.2	32.9	33.7	40.0
R487	Existing	361390	4886229	978	S09	5217		36.9	36.9		34.9	34.9	40.0
R488	Existing	362754	4887614	1186	S11	3520	12.3	37.2	37.2	11.4	35.1	35.1	40.0
R489	Existing	364327	4892571	1217	S15	1816	25.7	34.3	34.9	23.2	32.1	32.6	40.0
R491	Existing	364510	4892291	931	S15	1723	26.4	36.1	36.5	23.8	34.0	34.4	40.0
R492	Existing	364093	4892417	1024	S06	1557	27.6	34.7	35.5	25.2	32.6	33.3	40.0
R493	Existing	363947	4889535	722	S34	1701	19.7	39.7	39.7	18.9	37.6	37.7	40.0
R494	Vacant	357735	4886184	1468	S17	7400		31.7	31.7		29.6	29.6	40.0
R498	Vacant	368372	4894049	1169	S28	5896		34.7	34.7		32.6	32.6	40.0
R502	Vacant	369943	4892403	728	S33	6800		38.1	38.1		36.5	36.5	40.0
R506	Vacant	365394	4892923	963	S15	2803	20.1	35.4	35.5	17.3	33.4	33.5	40.0
R507	Existing	362913	4891806	902	S06	795	35.5	36.5	39.0	33.6	34.4	37.1	40.0
R508	Vacant	367543	4893804	999	S30	5060		35.7	35.7		33.6	33.6	40.0
R509	Vacant	360379	4890888	812	S04	2898	15.2	37.6	37.7	14.2	35.8	35.8	40.0
R510	Existing	364094	4892193	818	S06	1373	29.1	36.1	36.9	26.7	34.1	34.8	40.0
R511	Existing	366940	4893673	739	S30	4486	13.1	36.9	36.9	8.1	35.0	35.0	40.0
R512	Existing	364183	4892505	1139	S06	1679	26.7	34.3	35.0	24.2	32.2	32.8	40.0
R514	Existing	361461	4886275	947	S11	5148		37.2	37.2		35.2	35.2	40.0

Noise Receptor ID	Description	UTM NAD 83, Zone 18		Nearest source distance [m]			Sound pressure [dBA]						
				WTG		Sub- station	POR at 4.5 m			POR at 1.5 within 30 m			Limit
		X	Y	Distance	ID	Distance	Substation	WTGs	Total	Substation	WTGs	Total	
R515	Existing	364434	4892293	1003	S15	1670	26.8	35.8	36.3	24.2	33.7	34.2	40.0
R516	Existing	364116	4889770	802	S34	1573	20.4	39.3	39.3	19.5	37.1	37.2	40.0
R517	Existing	368681	4894038	998	S28	6160		35.4	35.4		33.5	33.5	40.0
R518	Existing	359892	4890709	817	S04	3399	13.0	37.9	38.0	12.1	36.1	36.1	40.0
R519	Existing	367020	4890008	643	S02	3905	7.7	38.9	38.9	6.5	37.1	37.1	40.0
R520	Existing	359123	4885906	1279	S10	6642		34.2	34.2		32.1	32.1	40.0
R521	Existing	364824	4892666	898	S15	2210	23.3	35.6	35.8	20.6	33.6	33.8	40.0
R522	Existing	359403	4890491	603	S29	3913	10.9	38.9	38.9	10.1	37.2	37.2	40.0
R523	Existing	361324	4891465	818	S22	1980	24.7	37.0	37.2	22.1	35.1	35.3	40.0
R524	Existing	361123	4891395	807	S22	2167	19.1	36.9	36.9	18.2	35.0	35.1	40.0
R525	Existing	359206	4890382	592	S29	4125	10.1	39.1	39.1	9.3	37.4	37.4	40.0
R526	Existing	362022	4891479	553	S31	1305	29.6	39.1	39.6	24.3	37.5	37.7	40.0
R527	Existing	361306	4891547	902	S22	2014	20.0	36.3	36.4	19.1	34.3	34.4	40.0
R528	Existing	367900	4894004	1368	S30	5468		34.4	34.4		32.3	32.3	40.0
R529	Vacant	363907	4892083	650	S06	1176	30.8	37.3	38.2	28.6	35.5	36.3	40.0
R531	Vacant	358037	4889756	1153	S01	5400		33.4	33.4		31.3	31.3	40.0
R532	Vacant	366125	4889308	829	S37	3369	7.8	39.3	39.3	6.4	37.5	37.5	40.0
R533	Existing	359064	4890367	676	S29	4268	9.6	38.3	38.3	8.8	36.5	36.5	40.0
R538	Existing	360529	4890971	903	S04	2743	16.0	37.4	37.4	15.1	35.4	35.5	40.0
R540	Vacant	358752	4890104	694	S01	4624	8.4	37.9	37.9	7.6	36.2	36.2	40.0
R541	Existing	359436	4890475	580	S29	3883	11.1	39.2	39.2	10.2	37.5	37.5	40.0
R544	Vacant	364977	4892760	895	S15	2385	22.3	35.5	35.7	19.5	33.6	33.8	40.0
R545	Vacant	365229	4887408	1178	S36	4176	8.6	33.5	33.6	7.9	31.4	31.5	40.0
R547	Existing	360683	4891197	937	S22	2589	16.7	36.5	36.5	15.8	34.3	34.3	40.0
R548	Existing	364600	4892460	926	S15	1906	25.1	35.7	36.1	22.5	33.7	34.0	40.0
R549	Existing	360940	4891214	754	S22	2332	18.1	37.5	37.6	17.2	35.7	35.8	40.0
R550	Existing	364362	4892284	1035	S06	1614	27.2	35.7	36.2	24.7	33.5	34.1	40.0
R551	Existing	357981	4889730	1204	S01	5462		33.1	33.1		30.9	30.9	40.0
R552	Existing	359148	4888646	779	S32	4794	7.8	39.3	39.3	7.0	37.3	37.3	40.0
R553	Existing	364289	4892295	1002	S06	1574	27.5	35.5	36.1	25.0	33.4	34.0	40.0
R554	Existing	364070	4892343	946	S06	1482	28.2	35.1	35.9	25.8	33.0	33.8	40.0
R555	Existing	363019	4888085	870	S05	3020	14.3	38.4	38.4	13.4	36.4	36.5	40.0
R557	Existing	363796	4892015	563	S06	1060	32.0	38.3	39.2	29.8	36.6	37.5	40.0
R558	Existing	364246	4892246	938	S06	1510	28.0	35.7	36.4	25.6	33.6	34.3	40.0
R559	Existing	364319	4892230	965	S06	1545	27.7	35.9	36.5	25.3	33.8	34.3	40.0
R560	Existing	366733	4889671	743	S02	3745	9.9	38.6	38.6	9.1	36.7	36.7	40.0
R561	Existing	358595	4888104	807	S17	5549		39.0	39.0		37.2	37.2	40.0
R562	Existing	359240	4890437	618	S29	4082	10.3	38.7	38.7	9.5	37.0	37.0	40.0
R565	Existing	368500	4894374	1380	S28	6174		32.9	32.9		30.8	30.8	40.0
R567	Existing	365546	4893199	1250	S15	3100	18.7	34.1	34.3	13.4	32.0	32.0	40.0



Noise Receptor ID	Description	UTM NAD 83, Zone 18		Nearest source distance [m]			Sound pressure [dBA]						
				WTG		Sub- station	POR at 4.5 m			POR at 1.5 within 30 m			Limit
		X	Y	Distance	ID	Distance	Substation	WTGs	Total	Substation	WTGs	Total	
R568	Vacant	367503	4893727	913	S30	4985	11.4	36.3	36.3	8.5	34.3	34.3	40.0
R569	Vacant	358913	4890177	677	S01	4452	9.0	38.8	38.8	8.2	37.1	37.1	40.0
R570	Existing	367045	4893676	735	S30	4573	12.8	37.0	37.0	9.9	35.2	35.2	40.0
R571	Vacant	364037	4889790	721	S34	1514	20.7	39.4	39.5	19.8	37.3	37.4	40.0
R574	Vacant	361281	4891427	789	S22	2016	24.4	37.2	37.4	21.8	35.3	35.5	40.0
R576	Existing	361477	4891672	1017	S22	1882	25.3	35.7	36.1	22.8	33.7	34.1	40.0
R579	Vacant	357971	4887678	807	S17	6305		37.0	37.0		35.2	35.2	40.0
R581	Existing	357958	4889741	1229	S01	5482		32.9	32.9		30.8	30.8	40.0
R582	Existing	368198	4891377	603	S13	4937	4.3	39.5	39.5	3.1	37.7	37.7	40.0
R584	Existing	359512	4890469	563	S29	3809	11.3	39.5	39.5	10.4	37.8	37.8	40.0
R585	Existing	362088	4891716	733	S31	1334	24.9	36.8	37.1	24.1	34.7	35.1	40.0
R587	Existing	367153	4893734	801	S30	4696	12.4	36.5	36.5	7.4	34.6	34.6	40.0
R590	Existing	369626	4893805	864	S28	6910		36.6	36.6		34.8	34.8	40.0
R591	Existing	363953	4892194	769	S06	1295	29.7	36.2	37.1	27.4	34.3	35.1	40.0
R593	Existing	360756	4891210	885	S22	2515	17.1	36.7	36.7	16.3	34.5	34.6	40.0
R594	Existing	363983	4892268	848	S06	1372	29.1	35.6	36.5	26.7	33.6	34.4	40.0
R595	Existing	364229	4892241	924	S06	1494	28.1	35.7	36.4	25.7	33.7	34.3	40.0
R596	Existing	364036	4892426	1014	S06	1535	27.8	34.6	35.4	25.4	32.5	33.2	40.0
R597	Vacant	364783	4892608	881	S15	2140	23.7	35.7	36.0	21.0	33.8	34.0	40.0
R602	Existing	362078	4891512	552	S31	1262	30.0	39.0	39.5	24.7	37.4	37.6	40.0
R604	Vacant	359924	4888947	964	S01	3976	10.5	39.5	39.5	9.6	37.3	37.3	40.0
R607	Existing	364312	4889960	888	S19	1542	20.8	39.0	39.1	19.7	36.9	37.0	40.0
R608	Vacant	369253	4891943	656	S12	6044		39.4	39.4		37.8	37.8	40.0
R609	Vacant	369303	4891969	659	S12	6097		39.5	39.5		37.8	37.8	40.0
R610	Vacant	362241	4886993	637	S11	4230	9.7	39.0	39.0	8.9	37.2	37.2	40.0
R611	Vacant	363447	4891985	608	S06	907	29.3	37.7	38.3	28.7	36.0	36.7	40.0
R612	Existing	359317	4890473	614	S29	4001	10.6	38.7	38.7	9.7	37.0	37.0	40.0
R613	Existing	358798	4888273	793	S32	5287		39.2	39.2		37.4	37.4	40.0
R614	Vacant	366592	4889595	785	S02	3646	10.1	38.8	38.8	9.2	36.9	36.9	40.0
R615	Existing	366692	4889634	766	S02	3722	9.9	38.5	38.5	9.1	36.7	36.7	40.0
R616	Vacant	366974	4889878	693	S02	3900	9.7	38.4	38.5	7.4	36.6	36.6	40.0
R619	Existing	364846	4890591	986	S37	1655	21.3	38.5	38.6	20.2	36.4	36.5	40.0
R620	Existing	362854	4891844	962	S31	856	34.7	36.2	38.5	32.8	34.1	36.5	40.0
R621	Vacant	364097	4892045	689	S06	1260	30.0	37.2	37.9	27.8	35.3	36.0	40.0
R622	Vacant	366374	4893149	698	S30	3722	11.7	37.8	37.8	10.7	35.9	35.9	40.0
R623	Vacant	361623	4891448	811	S22	1683	26.7	37.8	38.1	24.2	35.9	36.2	40.0
R625	Existing	362841	4891878	984	S31	892	34.3	36.0	38.2	32.3	33.9	36.2	40.0
R626	Existing	362457	4891736	716	S31	1034	32.2	37.1	38.3	30.0	35.2	36.3	40.0
R627	Vacant	362715	4887724	1158	S05	3416	12.7	37.7	37.7	11.9	35.6	35.6	40.0
R628	Existing	364176	4892227	886	S06	1450	28.4	35.8	36.5	26.1	33.7	34.4	40.0

Noise Receptor ID	Description	UTM NAD 83, Zone 18		Nearest source distance [m]			Sound pressure [dBA]						
				WTG		Sub- station	POR at 4.5 m			POR at 1.5 within 30 m			Limit
		X	Y	Distance	ID	Distance	Substation	WTGs	Total	Substation	WTGs	Total	
R631	Existing	364157	4892328	967	S06	1519	27.9	35.2	36.0	25.5	33.1	33.8	40.0
R632	Existing	367413	4893773	913	S30	4934	11.6	36.0	36.1	8.7	34.0	34.0	40.0
R633	Existing	362614	4891873	887	S31	1017	27.9	35.6	36.3	27.9	33.5	34.5	40.0
R636	Existing	360541	4891112	1014	S22	2728	16.0	36.5	36.6	15.1	34.4	34.5	40.0
R637	Existing	361463	4886045	1174	S11	5363		35.4	35.4		33.3	33.3	40.0
R638	Vacant	367596	4893832	1051	S30	5119		35.5	35.5		33.4	33.4	40.0
R641	Existing	361144	4891459	858	S22	2156	19.1	36.0	36.1	18.2	34.2	34.3	40.0
R642	Vacant	357783	4887487	921	S17	6567		35.7	35.7		33.8	33.8	40.0
R643	Existing	361178	4891489	875	S22	2127	19.3	36.0	36.1	18.4	34.1	34.2	40.0
R644	Vacant	357541	4887291	1144	S17	6876		33.7	33.7		31.7	31.7	40.0
R668	Vacant	364291	4892526	1203	S06	1758	26.1	34.4	35.0	23.7	32.2	32.8	40.0
R670	Existing	361834	4891347	600	S31	1457	28.4	39.4	39.7	26.0	37.6	37.9	40.0
R673	Existing	366974	4890051	582	S02	3849	9.6	39.6	39.6	6.7	37.9	37.9	40.0
R675	Vacant	364106	4892299	919	S06	1465	28.3	35.4	36.2	25.9	33.3	34.0	40.0
R676	Vacant	364056	4892399	995	S06	1522	27.9	34.8	35.6	25.5	32.6	33.4	40.0
R677	Existing	364118	4892402	1019	S06	1558	27.6	34.8	35.5	25.2	32.7	33.4	40.0
R686	Existing	357305	4887726	1443	S17	6850		32.0	32.0		29.8	29.8	40.0
R689	Vacant	357295	4887048	1413	S17	7216		31.8	31.8		29.6	29.6	40.0
R691	Existing	359074	4885854	1330	S10	6713		33.8	33.8		31.7	31.7	40.0
R693	Existing	361775	4886598	622	S11	4739	8.0	39.4	39.4	7.2	37.6	37.6	40.0
R694	Existing	358435	4889082	874	S01	5237		36.3	36.3		34.2	34.2	40.0
R695	Existing	359183	4890360	589	S29	4152	10.0	39.2	39.2	9.2	37.5	37.5	40.0
R696	Existing	359353	4890487	615	S29	3963	10.8	38.7	38.7	9.9	37.0	37.0	40.0
R697	Existing	359774	4890703	822	S29	3517	12.5	37.7	37.7	11.6	35.8	35.8	40.0
R698	Existing	360402	4890935	859	S04	2872	15.3	37.3	37.4	14.4	35.4	35.4	40.0
R699	Existing	362107	4891706	717	S31	1313	25.0	36.8	37.1	24.3	34.9	35.3	40.0
R700	Existing	362391	4892427	1399	S31	1595	27.3	32.5	33.6	24.9	30.3	31.4	40.0
R702	Existing	363925	4892260	826	S06	1337	29.4	35.7	36.6	27.1	33.7	34.6	40.0
R703	Existing	364024	4892195	792	S06	1334	29.4	36.1	37.0	27.1	34.2	34.9	40.0
R704	Existing	364126	4892157	800	S06	1364	29.1	36.3	37.0	26.9	34.3	35.0	40.0
R705	Existing	364195	4892263	927	S06	1491	28.1	35.6	36.3	25.7	33.5	34.2	40.0
R706	Vacant	364297	4892527	1207	S06	1762	26.1	34.4	35.0	23.6	32.2	32.8	40.0
R707	Existing	364963	4892327	555	S15	2094	24.0	39.2	39.3	21.1	37.7	37.8	40.0
R708	Existing	365565	4893159	1214	S15	3087	18.7	34.4	34.5	13.5	32.2	32.3	40.0
R709	Vacant	364932	4890605	942	S37	1734	20.8	38.8	38.8	19.7	36.7	36.8	40.0
R710	Existing	364665	4890379	928	S19	1568	21.4	38.7	38.8	20.3	36.6	36.7	40.0
R711	Vacant	362959	4888080	853	S05	3032	14.2	38.6	38.6	13.4	36.6	36.6	40.0
R712	Existing	362837	4886350	1471	S11	4765	7.9	33.0	33.0	7.1	30.7	30.8	40.0
R723	Existing	366870	4893610	690	S30	4392	13.4	37.4	37.4	8.3	35.5	35.6	40.0
R724	Existing	367973	4891218	643	S13	4705	4.7	39.3	39.3	1.5	37.5	37.5	40.0

Noise Receptor ID	Description	UTM NAD 83, Zone 18		Nearest source distance [m]			Sound pressure [dBA]						
				WTG		Sub- station	POR at 4.5 m			POR at 1.5 within 30 m			Limit
		X	Y	Distance	ID	Distance	Substation	WTGs	Total	Substation	WTGs	Total	
R725	Vacant	369414	4893893	831	S28	6751		36.7	36.7		34.9	34.9	40.0
R726	Existing	368834	4894356	1255	S28	6450		33.3	33.3		31.2	31.2	40.0
R727	Existing	366503	4892626	622	S30	3578	12.0	40.0	40.0	11.0	38.1	38.1	40.0

**Table C.2 Noise Impact Summary – Participating Project Noise Receptors (51 receptors)**

The table is sorted by noise receptors ID; “Vacant” = vacant lot noise receptor, “Existing” = existing dwelling; “Total” = combined contribution from all sources (substation and WTGs); blank cells in “Sound pressure” columns = POR at more than 5000 m from source.

Noise Receptor ID	Description	UTM NAD 83, zone 18		Nearest source distance [m]			Sound pressure [dBA]					
				WTG		Sub-station	POR at 4.5 m			POR at 1.5 within 30 m		
		X	Y	Distance	ID	Distance	Substation	WTGs	Total	Substation	WTGs	Total
R015	Existing	365758	4889070	816	S19	3208	7.0	39.7	39.7	5.8	37.8	37.9
R039	Vacant	359608	4888818	853	S01	4312	9.4	39.6	39.6	8.5	37.5	37.5
R044	Vacant	362910	4890438	679	S34	749	28.4	39.8	40.1	27.1	37.7	38.1
R048	Vacant	362789	4890459	724	S31	797	28.3	39.7	40.0	27.4	37.6	38.0
R076	Vacant	361163	4889513	869	S16	2635	15.8	40.3	40.3	14.8	38.3	38.3
R086	Vacant	358239	4887766	644	S17	6032		39.1	39.1		37.4	37.4
R115	Vacant	365282	4888463	696	S36	3314	9.5	39.7	39.7	8.7	38.0	38.0
R134	Existing	367322	4890451	836	S02	4104	6.2	38.5	38.5	4.7	36.6	36.6
R140	Existing	363261	4892098	804	S06	1002	28.0	35.9	36.5	28.1	33.9	34.9
R156	Vacant	358969	4890147	630	S01	4403	9.2	39.5	39.5	8.3	37.9	37.9
R177	Existing	366495	4889660	712	S02	3531	10.3	39.8	39.8	9.4	38.0	38.0
R179	Vacant	366131	4889365	798	S37	3345	8.7	39.7	39.7	6.5	37.9	37.9
R183	Vacant	359023	4888530	757	S32	4962	7.2	39.2	39.2	6.5	37.3	37.3
R211	Vacant	362482	4890207	834	S31	1187	23.3	39.7	39.8	22.4	37.6	37.7
R224	Vacant	365458	4888627	710	S21	3300	9.6	39.2	39.2	8.8	37.4	37.4
R248	Vacant	363980	4889192	913	S21	2032	18.2	39.5	39.6	17.2	37.4	37.4
R250	Vacant	361864	4886650	599	S11	4662	8.3	39.4	39.4	7.5	37.7	37.7
R254	Existing	360129	4890712	694	S04	3163	14.0	38.6	38.6	13.1	36.8	36.8
R255	Vacant	360406	4889168	908	S04	3452	12.5	39.6	39.6	11.7	37.5	37.5
R257	Vacant	365016	4892682	808	S15	2360	22.4	36.3	36.5	19.7	34.4	34.6
R297	Existing	365371	4888610	651	S21	3255	9.6	39.8	39.8	8.8	38.0	38.0
R310	Existing	363457	4892030	643	S06	953	28.8	37.3	37.9	28.2	35.5	36.3
R328	Vacant	363066	4891848	783	S06	779	35.7	36.7	39.2	30.8	34.7	36.2
R329	Vacant	358599	4888058	761	S17	5571		39.4	39.4		37.6	37.6
R337	Existing	368133	4891327	605	S13	4869	4.7	39.5	39.5	2.9	37.7	37.7
R373	Existing	369538	4892176	661	S33	6361		40.1	40.1		38.5	38.5
R376	Existing	362412	4889866	783	S20	1499	21.6	40.6	40.6	20.6	38.6	38.7
R383	Existing	367296	4890391	807	S02	4088	6.5	38.5	38.5	4.3	36.5	36.5
R399	Vacant	369451	4892050	690	S12	6255		39.5	39.5		37.8	37.8
R427	Vacant	361304	4891372	730	S22	1984	24.6	37.7	37.9	22.0	35.9	36.1
R435	Vacant	363314	4888993	492	S20	2103	18.1	42.4	42.4	17.2	40.9	40.9
R441	Existing	361668	4886460	746	S11	4904	7.5	38.4	38.4	6.7	36.5	36.5
R457	Existing	365771	4889428	504	S37	3006	14.4	42.5	42.5	13.5	40.9	41.0
R463	Vacant	361867	4889920	848	S22	1830	19.5	40.1	40.1	18.4	38.0	38.1
R465	Vacant	359201	4888621	732	S32	4762	7.9	39.6	39.6	7.1	37.7	37.7
R469	Vacant	358454	4887914	654	S17	5771		39.6	39.6		37.9	37.9

Noise Receptor ID	Description	UTM NAD 83, zone 18		Nearest source distance [m]			Sound pressure [dBA]					
				WTG		Sub-station	POR at 4.5 m			POR at 1.5 within 30 m		
		X	Y	Distance	ID	Distance	Substation	WTGs	Total	Substation	WTGs	Total
R503	Vacant	363155	4888902	434	S20	2197	17.8	43.8	43.8	16.9	42.4	42.4
R505	Vacant	367435	4890592	857	S14	4196	9.8	38.4	38.4	5.0	36.4	36.4
R537	Vacant	366953	4893452	519	S30	4374	13.5	39.5	39.6	10.6	38.0	38.0
R556	Existing	366391	4889653	684	S27	3439	10.4	40.3	40.4	9.5	38.6	38.6
R573	Vacant	363517	4891934	531	S06	875	29.7	38.7	39.2	29.1	37.1	37.8
R577	Vacant	359041	4890166	581	S29	4329	9.4	40.0	40.0	8.6	38.4	38.4
R578	Vacant	365567	4888834	716	S21	3224	13.3	39.5	39.5	9.0	37.7	37.7
R598	Existing	360680	4889284	838	S04	3160	13.6	39.9	39.9	12.8	37.8	37.8
R600	Existing	362831	4891653	793	S31	709	36.7	37.3	40.0	34.4	35.2	37.8
R617	Existing	358252	4887163	455	S17	6375		41.4	41.4		40.1	40.1
R618	Existing	363401	4892017	659	S06	931	29.1	37.1	37.8	28.5	35.4	36.2
R667	Vacant	361446	4889693	781	S16	2300	17.3	40.3	40.4	16.3	38.3	38.4
R678	Vacant	364467	4889566	640	S19	1943	18.7	40.9	40.9	17.6	39.0	39.1
R701	Existing	363294	4892136	817	S06	1041	27.6	35.7	36.3	27.0	33.7	34.6
R720	Vacant	363943	4889237	907	S34	1977	18.5	39.5	39.6	17.5	37.4	37.4

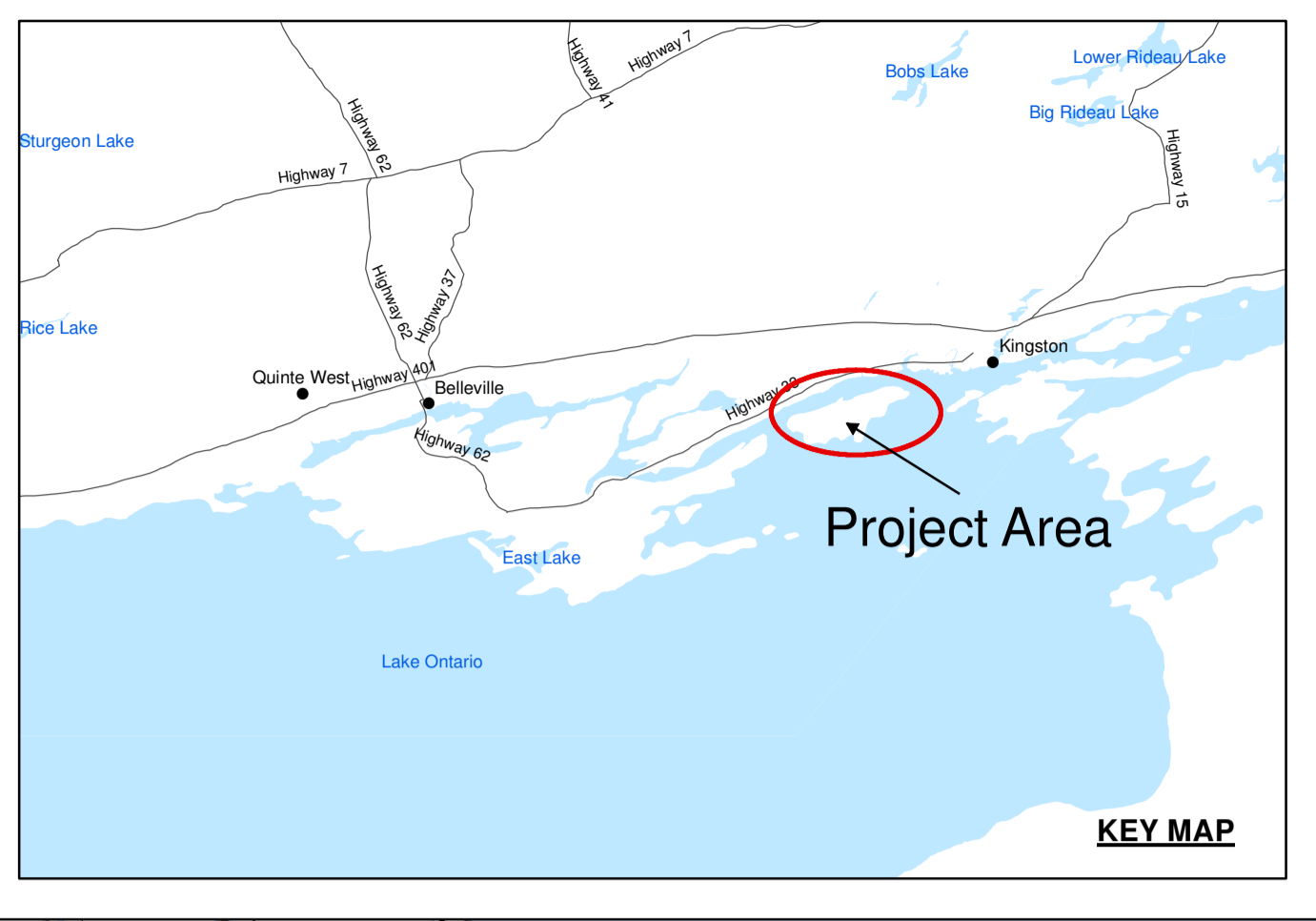
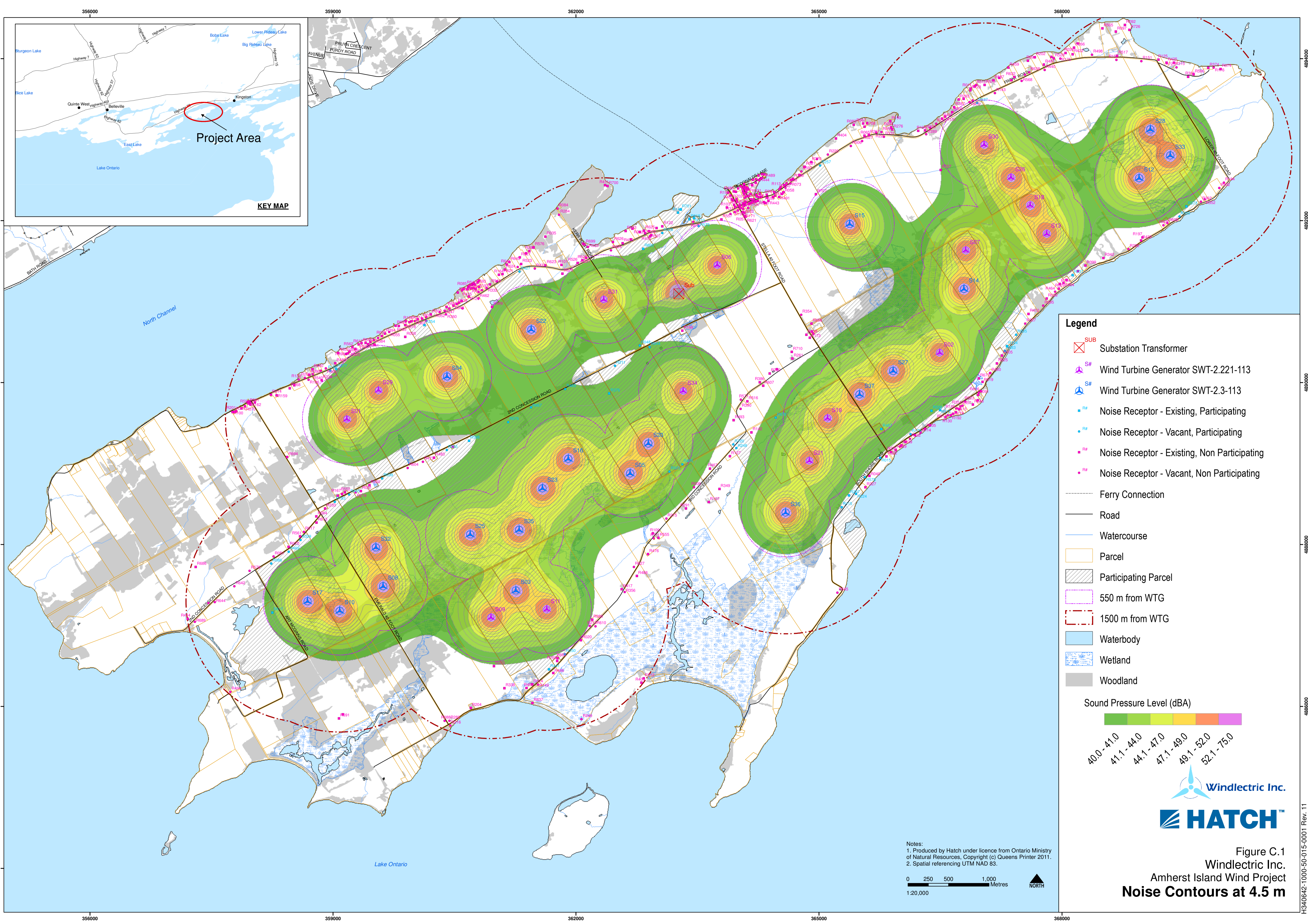

- Legend**
- Substation Transformer
  - Wind Turbine Generator SWT-2.221-113
  - Wind Turbine Generator SWT-2.3-113
  - Noise Receptor - Existing, Participating
  - Noise Receptor - Vacant, Participating
  - Noise Receptor - Existing, Non Participating
  - Noise Receptor - Vacant, Non Participating
  - Ferry Connection
  - Road
  - Watercourse
  - Parcel
  - Participating Parcel
  - 550 m from WTG
  - 1500 m from WTG
  - Waterbody
  - Wetland
  - Woodland

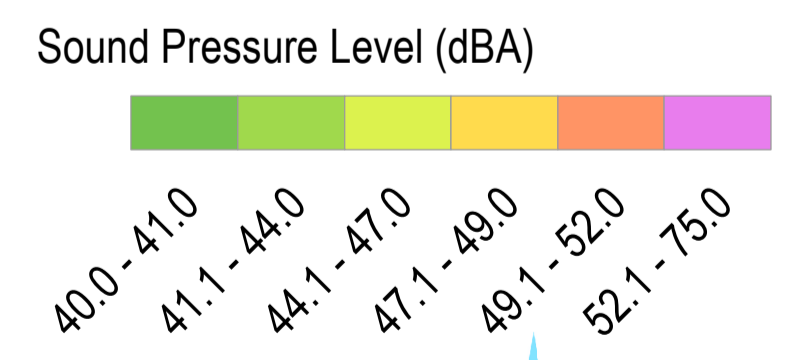

Notes:  
 1. Produced by Hatch under licence from Ontario Ministry of Natural Resources, Copyright (c) Queens Printer 2011.  
 2. Spatial referencing UTM NAD 83.

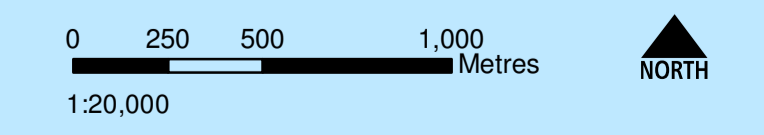
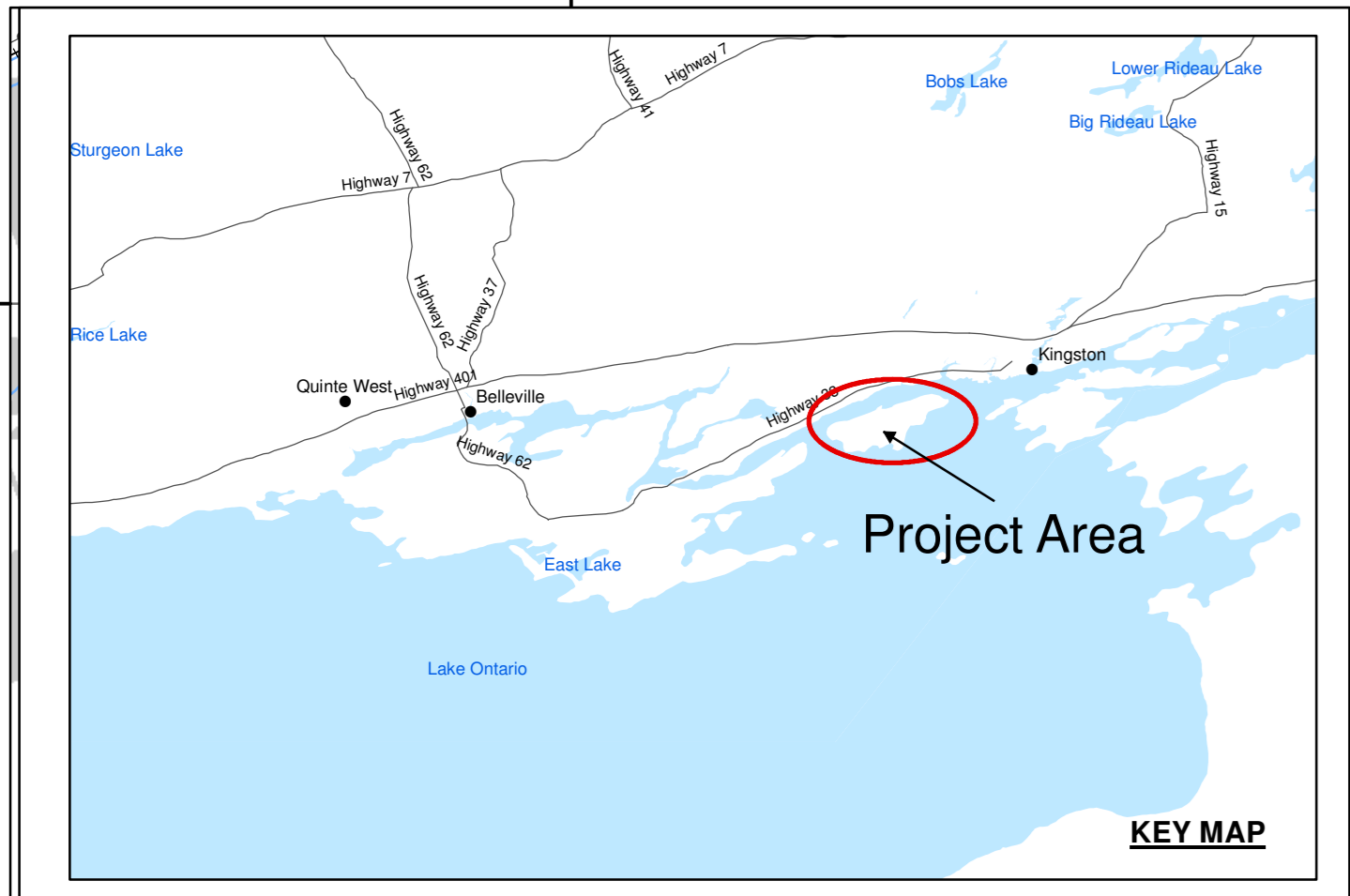
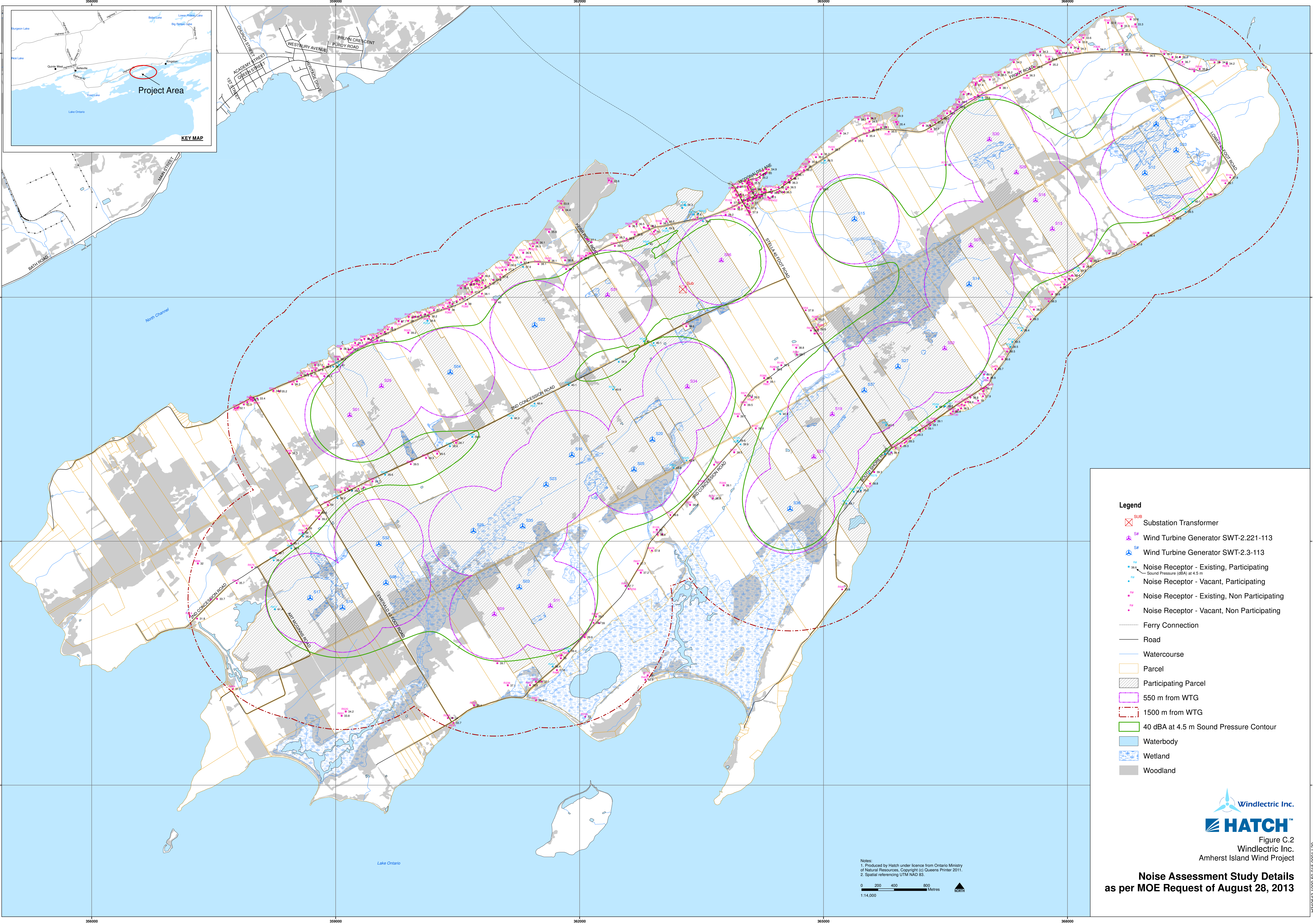

Figure C.1  
 Windlectric Inc.  
 Amherst Island Wind Project  
**Noise Contours at 4.5 m**



- Legend**
- Substation Transformer
  - Wind Turbine Generator SWT-2.221-113
  - Wind Turbine Generator SWT-2.3-113
  - Noise Receptor - Existing, Participating  
- Sound Pressure (dBA) at 4.5 m
  - Noise Receptor - Vacant, Participating
  - Noise Receptor - Existing, Non Participating
  - Noise Receptor - Vacant, Non Participating
  - Ferry Connection
  - Road
  - Watercourse
  - Parcel
  - Participating Parcel
  - 550 m from WTG
  - 1500 m from WTG
  - 40 dBA at 4.5 m Sound Pressure Contour
  - Waterbody
  - Wetland
  - Woodland

Notes:  
 1. Produced by Hatch under licence from Ontario Ministry of Natural Resources, Copyright (c) Queens Printer 2011.  
 2. Spatial referencing UTM NAD 83.

0 200 400 800 Metres  
 1:14,000

Figure C.2  
 Windlectric Inc.  
 Amherst Island Wind Project  
**Noise Assessment Study Details**  
 as per MOE Request of August 28, 2013

363600

363800

364000

364200







4892000

4891800



4891600



**Legend**

-  Wind Turbine Generator SWT-2.221-113
-  Noise Receptor - Existing, Non Participating (School)
-  Road
-  Watercourse
-  550 m from WTG
-  Parcel (PIN)

**Noise Levels**

-  40 dBA - 1.5m Above Ground Level
-  40 dBA - 4.5m Above Ground Level

Notes:  
 1. Produced by Hatch under licence from Ontario Ministry of Natural Resources, Copyright (c) Queens Printer 2014.  
 2. Spatial referencing UTM NAD 83, Zone 18.

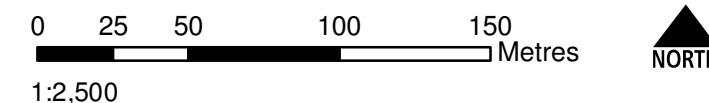

**Figure C-3**  
**Windlectric Inc.**  
 Amherst Island Wind Project  
**Receptor R557**  
**Noise Contours**





# Appendix D

## CADNA-A Sample Calculation and Verification

## Calculation of Sound Pressure Levels from Wind Turbine using ISO 9613-2

### Amherst Island Wind Project

#### Background

As requested by the Ministry of Environment in the Noise Guidelines for Wind Farms in Section 6.7 – Appendices (October 2008), a sample calculation should be included in the Noise Assessment Report. The sample calculation must include at least one detailed calculation for a source to point of reception “pair,” preferably addressing the closest wind turbine unit, and it must represent all other “pairs”.

For this project, a POR representing non-participating Noise Receptor R080 along with S11 turbine were chosen as a “pair”.

The calculations are based on ISO 9613-2: Acoustics – Attenuation of sound during propagation outdoors – General Method of Calculation. The ground attenuation coefficient was assumed as 0.7, as suggested by the MOE Guidelines (Section 6.4.10 – Specific Parameters). Ambient temperature and relative humidity were assumed at 10°C and 70%, respectively. The octave band data for the Siemens SWT-2.3-113 wind turbine generator were provided by the manufacturer and adjusted for wind shear. The octave band data used in this calculation is identical to that used in CADNA-A model.

#### Input parameters

POR height  $h_r := 4.5\text{m}$

Noise source height  $h_s := 99.5\text{m}$

Coordinates and elevation of R080 POR, Zr below included ground elevation and receptor height

$X_r := 362200.34\text{m}$      $Y_r := 4887074.70\text{m}$      $Z_r := 84.5\text{m}$

Coordinates and elevation of S11 noise source, Zr below included ground elevation and receptor height

$X_s := 361640.50\text{m}$      $Y_s := 4887205.50\text{m}$      $Z_s := 182.57\text{m}$

Ground absorption coefficient  $G_a := 0.7$

Wind turbine (noise source) sound power emission

at 63 Hz	$L_{w\_63} := 84.8\text{dBA}$
at 125 Hz	$L_{w\_125} := 90.9\text{dBA}$
at 250 Hz	$L_{w\_250} := 97.6\text{dBA}$
at 500 Hz	$L_{w\_500} := 98.2\text{dBA}$
at 1000 Hz	$L_{w\_1000} := 98.8\text{dBA}$
at 2000 Hz	$L_{w\_2000} := 95.6\text{dBA}$
at 4000 Hz	$L_{w\_4000} := 84.1\text{dBA}$
at 8000 Hz	$L_{w\_8000} := 65.6\text{dBA}$

Distance from POR to source

$$d := \sqrt{(X_R - X_S)^2 + (Y_R - Y_S)^2 + (Z_R - Z_S)^2} = 583.2\text{m} \text{ 3D distance between the source and POR}$$

$$d_p := \sqrt{(X_R - X_S)^2 + (Y_R - Y_S)^2} = 574.9\text{m} \text{ Projected distance between the source and POR}$$

Combined sound power level for the source

$$\text{Total\_L}_w := 10 \cdot \log \left( 10^{\frac{L_{w\_63}}{10}} + 10^{\frac{L_{w\_125}}{10}} + 10^{\frac{L_{w\_250}}{10}} + 10^{\frac{L_{w\_500}}{10}} + 10^{\frac{L_{w\_1000}}{10}} + 10^{\frac{L_{w\_2000}}{10}} + 10^{\frac{L_{w\_4000}}{10}} + 10^{\frac{L_{w\_8000}}{10}} + \dots \right)$$

$$\text{Total\_L}_w = 104\text{dBA}$$

## Attenuation

Attenuation due to geometrical divergence

$$\text{Att\_div} := 20 \cdot \log\left(\frac{d}{1\text{m}}\right) + 11 = 66.3 \cdot \text{dB}$$

Attenuation due to atmospheric absorption at ambient temperature and relative humidity of 10°C and 70%

$$\text{at 63 Hz} \quad \text{Att\_atm\_63} := 0.1 \frac{\text{dB}}{\text{km}} \cdot d = 0.058 \cdot \text{dB}$$

$$\text{at 125 Hz} \quad \text{Att\_atm\_125} := 0.4 \frac{\text{dB}}{\text{km}} \cdot d = 0.233 \cdot \text{dB}$$

$$\text{at 250 Hz} \quad \text{Att\_atm\_250} := 1.0 \frac{\text{dB}}{\text{km}} \cdot d = 0.583 \cdot \text{dB}$$

$$\text{at 500 Hz} \quad \text{Att\_atm\_500} := 1.9 \frac{\text{dB}}{\text{km}} \cdot d = 1.108 \cdot \text{dB}$$

$$\text{at 1000 Hz} \quad \text{Att\_atm\_1000} := 3.7 \frac{\text{dB}}{\text{km}} \cdot d = 2.158 \cdot \text{dB}$$

$$\text{at 2000 Hz} \quad \text{Att\_atm\_2000} := 9.7 \frac{\text{dB}}{\text{km}} \cdot d = 5.657 \cdot \text{dB}$$

$$\text{at 4000 Hz} \quad \text{Att\_atm\_4000} := 32.8 \frac{\text{dB}}{\text{km}} \cdot d = 19.13 \cdot \text{dB}$$

$$\text{at 8000 Hz} \quad \text{Att\_atm\_8000} := 117.0 \frac{\text{dB}}{\text{km}} \cdot d = 68.237 \cdot \text{dB}$$

Attenuation coefficients

$$a_1(h) := 1.5 + 3.0 \cdot e^{-0.12 \left(\frac{h}{\text{m}} - 5\right)^2} \cdot \left(1 - e^{\frac{-d_p}{50 \cdot \text{m}}}\right) + 5.7 \cdot e^{-0.09 \cdot \frac{h^2}{\text{m}^2}} \cdot \left(1 - e^{-2.8 \cdot 10^{-6} \cdot \frac{d_p^2}{\text{m}^2}}\right)$$

$$b_1(h) := 1.5 + 8.6 \cdot e^{-0.09 \cdot \frac{h^2}{\text{m}^2}} \cdot \left(1 - e^{\frac{-d_p}{50 \cdot \text{m}}}\right)$$

$$c_1(h) := 1.5 + 14.0 \cdot e^{-0.46 \cdot \frac{h^2}{\text{m}^2}} \cdot \left(1 - e^{\frac{-d_p}{50 \cdot \text{m}}}\right)$$

$$d_1(h) := 1.5 + 5.0 \cdot e^{-0.9 \cdot \frac{h^2}{\text{m}^2}} \cdot \left(1 - e^{\frac{-d_p}{50 \cdot \text{m}}}\right)$$

$$q := \begin{cases} 0 & \text{if } d_p \leq 30 \cdot (h_r + h_s) \\ 1 - \frac{30 \cdot (h_r + h_s)}{d_p} & \text{otherwise} \end{cases}$$

#### Attenuation due to ground absorption - source

$$a_1(h_s) = 1.5 \quad b_1(h_s) = 1.5 \quad c_1(h_s) = 1.5 \quad d_1(h_s) = 1.5$$

$$\text{at 63 Hz} \quad \text{Att\_gr\_s\_63} := -1.5 \text{ dB}$$

$$\text{at 125 Hz} \quad \text{Att\_gr\_s\_125} := -1.5 + G_a \cdot a_1(h_s) = -0.45 \text{ dB}$$

$$\text{at 250 Hz} \quad \text{Att\_gr\_s\_250} := -1.5 + G_a \cdot b_1(h_s) = -0.45 \text{ dB}$$

$$\text{at 500 Hz} \quad \text{Att\_gr\_s\_500} := -1.5 + G_a \cdot c_1(h_s) = -0.45 \text{ dB}$$

$$\text{at 1000 Hz} \quad \text{Att\_gr\_s\_1000} := -1.5 + G_a \cdot d_1(h_s) = -0.45 \text{ dB}$$

$$\text{at 2000 Hz} \quad \text{Att\_gr\_s\_2000} := -1.5 \cdot (1 - G_a) = -0.45 \text{ dB}$$

$$\text{at 4000 Hz} \quad \text{Att\_gr\_s\_4000} := -1.5 \cdot (1 - G_a) = -0.45 \text{ dB}$$

$$\text{at 8000 Hz} \quad \text{Att\_gr\_s\_8000} := -1.5 \cdot (1 - G_a) = -0.45 \text{ dB}$$

#### Attenuation due to ground absorption - middle

$$q = 0$$

$$\text{at 63 Hz} \quad \text{Att\_gr\_m\_63} := -3 \cdot q^2 = 0 \text{ dB}$$

$$\text{at 125 Hz} \quad \text{Att\_gr\_m\_125} := -3 \cdot q \cdot (1 - G_a) = 0 \text{ dB}$$

$$\text{at 250 Hz} \quad \text{Att\_gr\_m\_250} := -3 \cdot q \cdot (1 - G_a) = 0 \text{ dB}$$

$$\text{at 500 Hz} \quad \text{Att\_gr\_m\_500} := -3 \cdot q \cdot (1 - G_a) = 0 \text{ dB}$$

$$\text{at 1000 Hz} \quad \text{Att\_gr\_m\_1000} := -3 \cdot q \cdot (1 - G_a) = 0 \text{ dB}$$

$$\text{at 2000 Hz} \quad \text{Att\_gr\_m\_2000} := -3 \cdot q \cdot (1 - G_a) = 0 \text{ dB}$$

$$\text{at 4000 Hz} \quad \text{Att\_gr\_m\_4000} := -3 \cdot q \cdot (1 - G_a) = 0 \text{ dB}$$

$$\text{at 8000 Hz} \quad \text{Att\_gr\_m\_8000} := -3 \cdot q \cdot (1 - G_a) = 0 \text{ dB}$$

### Attenuation due to ground absorption - POR

$$a_1(h_r) = 4.967 \quad b_1(h_r) = 2.89 \quad c_1(h_r) = 1.501 \quad d_1(h_r) = 1.5$$

at 63 Hz  $Att_{gr\_r\_63} := -1.5 \text{ dB}$

at 125 Hz  $Att_{gr\_r\_125} := -1.5 + G_a \cdot a_1(h_r) = 1.977 \cdot \text{dB}$

at 250 Hz  $Att_{gr\_r\_250} := -1.5 + G_a \cdot b_1(h_r) = 0.523 \cdot \text{dB}$

at 500 Hz  $Att_{gr\_r\_500} := -1.5 + G_a \cdot c_1(h_r) = -0.449 \cdot \text{dB}$

at 1000 Hz  $Att_{gr\_r\_1000} := -1.5 + G_a \cdot d_1(h_r) = -0.45 \cdot \text{dB}$

at 2000 Hz  $Att_{gr\_r\_2000} := -1.5 \cdot (1 - G_a) = -0.45 \cdot \text{dB}$

at 4000 Hz  $Att_{gr\_r\_4000} := -1.5 \cdot (1 - G_a) = -0.45 \cdot \text{dB}$

at 8000 Hz  $Att_{gr\_r\_8000} := -1.5 \cdot (1 - G_a) = -0.45 \cdot \text{dB}$

### Total ground attenuation for each frequency

at 63 Hz  $Att_{gr\_63} := Att_{gr\_s\_63} + Att_{gr\_m\_63} + Att_{gr\_r\_63} = -3 \cdot \text{dB}$

at 125 Hz  $Att_{gr\_125} := Att_{gr\_s\_125} + Att_{gr\_m\_125} + Att_{gr\_r\_125} = 1.5 \cdot \text{dB}$

at 250 Hz  $Att_{gr\_250} := Att_{gr\_s\_250} + Att_{gr\_m\_250} + Att_{gr\_r\_250} = 0.073 \cdot \text{dB}$

at 500 Hz  $Att_{gr\_500} := Att_{gr\_s\_500} + Att_{gr\_m\_500} + Att_{gr\_r\_500} = -0.9 \cdot \text{dB}$

at 1000 Hz  $Att_{gr\_1000} := Att_{gr\_s\_1000} + Att_{gr\_m\_1000} + Att_{gr\_r\_1000} = -0.9 \cdot \text{dB}$

at 2000 Hz  $Att_{gr\_2000} := Att_{gr\_s\_2000} + Att_{gr\_m\_2000} + Att_{gr\_r\_2000} = -0.9 \cdot \text{dB}$

at 4000 Hz  $Att_{gr\_4000} := Att_{gr\_s\_4000} + Att_{gr\_m\_4000} + Att_{gr\_r\_4000} = -0.9 \cdot \text{dB}$

at 8000 Hz  $Att_{gr\_8000} := Att_{gr\_s\_8000} + Att_{gr\_m\_8000} + Att_{gr\_r\_8000} = -0.9 \cdot \text{dB}$

### Total attenuation for each frequency

at 63 Hz  $Att_{63} := Att_{div} + Att_{atm\_63} + Att_{gr\_63} = 63.375 \cdot \text{dB}$

at 125 Hz  $Att_{125} := Att_{div} + Att_{atm\_125} + Att_{gr\_125} = 68.077 \cdot \text{dB}$

at 250 Hz  $Att_{250} := Att_{div} + Att_{atm\_250} + Att_{gr\_250} = 66.973 \cdot \text{dB}$

at 500 Hz  $Att_{500} := Att_{div} + Att_{atm\_500} + Att_{gr\_500} = 66.526 \cdot \text{dB}$

at 1000 Hz  $Att_{1000} := Att_{div} + Att_{atm\_1000} + Att_{gr\_1000} = 67.575 \cdot \text{dB}$

at 2000 Hz  $Att_{2000} := Att_{div} + Att_{atm\_2000} + Att_{gr\_2000} = 71.074 \cdot \text{dB}$

at 4000 Hz  $Att_{4000} := Att_{div} + Att_{atm\_4000} + Att_{gr\_4000} = 84.546 \cdot \text{dB}$

at 8000 Hz  $Att_{8000} := Att_{div} + Att_{atm\_8000} + Att_{gr\_8000} = 133.654 \cdot \text{dB}$

**Sound pressure levels at the POR**

- at 63 Hz  $L_{p\_63} := L_{w\_63} - Att_{63} = 21.4 \cdot \text{dBA}$
- at 125 Hz  $L_{p\_125} := L_{w\_125} - Att_{125} = 22.8 \cdot \text{dBA}$
- at 250 Hz  $L_{p\_250} := L_{w\_250} - Att_{250} = 30.6 \cdot \text{dBA}$
- at 500 Hz  $L_{p\_500} := L_{w\_500} - Att_{500} = 31.7 \cdot \text{dBA}$
- at 1000 Hz  $L_{p\_1000} := L_{w\_1000} - Att_{1000} = 31.2 \cdot \text{dBA}$
- at 2000 Hz  $L_{p\_2000} := L_{w\_2000} - Att_{2000} = 24.5 \cdot \text{dBA}$
- at 4000 Hz  $L_{p\_4000} := L_{w\_4000} - Att_{4000} = -0.4 \cdot \text{dBA}$
- at 8000 Hz  $L_{p\_8000} := L_{w\_8000} - Att_{8000} = -68.1 \cdot \text{dBA}$

$$\text{Total\_Lp} := 10 \cdot \log \left( 10^{\frac{L_{p\_63}}{10}} + 10^{\frac{L_{p\_125}}{10}} + 10^{\frac{L_{p\_250}}{10}} + 10^{\frac{L_{p\_500}}{10}} + 10^{\frac{L_{p\_1000}}{10}} + 10^{\frac{L_{p\_2000}}{10}} + 10^{\frac{L_{p\_4000}}{10}} + 10^{\frac{L_{p\_8000}}{10}} \dots \right)$$

**Total\_Lp = 36.6 dBA**

**Impact of S11 on R080 POR as calculated by CADNA-A**

Frequency [Hz]	31.5	63	125	250	500	1000	2000	4000	8000	Total
Sound pressure [dBA]		21.4	22.8	30.6	31.7	31.3	24.5	-0.4	-68.0	36.6

**Conclusion**

Based on the calculation procedure provided in ISO 9613-2 and the parameters suggested by the Ministry of Environment in the Noise Guidelines for Wind Farms, Section 6.4.10 (October 2008), the estimated sound pressure level at the point of reception R080 produced by the noise source (wind turbine generator) S11 is 36.6 dBA, which is equal to the prediction of CADNA-A for the same POR (36.6 dBA).

It is important to note that POR R080 receives sound contributions from several sources, and the level shown above (36.6 dBA) corresponds only to the contribution from S11. The total sound pressure level at this POR was estimated by CADNA-A at 39.7 dBA.

Both the air and ground attenuation components were included and calculated based on ISO 9613-2 assuming 10°C ambient temperature and 70% relative humidity.

Configuration	
Parameter	Value
General	
Country	(user defined)
Max. Error (dB)	0.00
Max. Search Radius (m)	5000.00
Min. Dist Src to Rcvr	0.00
Partition	
Raster Factor	0.50
Max. Length of Section (m)	1000.00
Min. Length of Section (m)	1.00
Min. Length of Section (%)	0.00
Proj. Line Sources	On
Proj. Area Sources	On
Ref. Time	
Reference Time Day (min)	960.00
Reference Time Night (min)	480.00
Daytime Penalty (dB)	0.00
Recr. Time Penalty (dB)	0.00
Night-time Penalty (dB)	0.00
DTM	
Standard Height (m)	0.00
Model of Terrain	Triangulation
Reflection	
max. Order of Reflection	1
Search Radius Src	100.00
Search Radius Rcvr	100.00
Max. Distance Source - Rcvr	1000.00 1000.00
Min. Distance Rcvr - Reflector	1.00 1.00
Min. Distance Source - Reflector	0.10
Industrial (ISO 9613)	
Lateral Diffraction	some Obj
Obst. within Area Src do not shield	On
Screening	
	Excl. Ground Att. over Barrier
	Dz with limit (20/25)
Barrier Coefficients C1,2,3	3.0 20.0 0.0
Temperature (°C)	10
rel. Humidity (%)	70
Ground Absorption G	0.70
Wind Speed for Dir. (m/s)	3.0
Roads (RLS-90)	
Strictly acc. to RLS-90	
Railways (Schall 03)	
Strictly acc. to Schall 03 / Schall-Transrapid	
Aircraft (???)	
Strictly acc. to AzB	



Receiver  
 Name: Existing  
 ID: R080  
 X: 362200.34  
 Y: 4887074.70  
 Z: 84.50

Point Source, ISO 9613, Name: "Substation", ID: "Subs"

Nr.	X (m)	Y (m)	Z (m)	Refl.	Freq. (Hz)	LxT dB(A)	LxN dB(A)	K0 (dB)	Dc (dB)	Adiv (dB)	Aatm (dB)	Agr (dB)	Afol (dB)	Ahous (dB)	Abar (dB)	Cmet (dB)	RL (dB)	LrT dB(A)	LrN dB(A)
1	363269.13	4891095.48	94.00	0	32	60.6	60.6	0.0	0.0	83.4	0.1	-5.8	0.0	0.0	4.8	0.0	-0.0	-21.9	-21.9
2	363269.13	4891095.48	94.00	0	63	77.8	77.8	0.0	0.0	83.4	0.5	-5.8	0.0	0.0	4.8	0.0	-0.0	-5.0	-5.0
3	363269.13	4891095.48	94.00	0	125	90.9	90.9	0.0	0.0	83.4	1.7	3.8	0.0	0.0	1.0	0.0	-0.0	1.0	1.0
4	363269.13	4891095.48	94.00	0	250	96.4	96.4	0.0	0.0	83.4	4.3	0.7	0.0	0.0	4.1	0.0	-0.0	3.9	3.9
5	363269.13	4891095.48	94.00	0	500	101.8	101.8	0.0	0.0	83.4	8.0	-1.7	0.0	0.0	4.8	0.0	-0.0	7.3	7.3
6	363269.13	4891095.48	94.00	0	1000	99.0	99.0	0.0	0.0	83.4	15.2	-1.7	0.0	0.0	4.9	0.0	-0.0	-2.7	-2.7
7	363269.13	4891095.48	94.00	0	2000	95.2	95.2	0.0	0.0	83.4	40.2	-1.7	0.0	0.0	5.0	0.0	-0.0	-31.7	-31.7
8	363269.13	4891095.48	94.00	0	4000	90.0	90.0	0.0	0.0	83.4	136.3	-1.7	0.0	0.0	5.2	0.0	-0.0	-133.2	-133.2
9	363269.13	4891095.48	94.00	0	8000	79.9	79.9	0.0	0.0	83.4	486.3	-1.7	0.0	0.0	5.6	0.0	-0.0	-493.7	-493.7

Point Source, ISO 9613, Name: "(untitled)", ID: "S01"

Nr.	X (m)	Y (m)	Z (m)	Refl.	Freq. (Hz)	LxT dB(A)	LxN dB(A)	K0 (dB)	Dc (dB)	Adiv (dB)	Aatm (dB)	Agr (dB)	Afol (dB)	Ahous (dB)	Abar (dB)	Cmet (dB)	RL (dB)	LrT dB(A)	LrN dB(A)
1	359172.10	4889551.06	184.50	0	63	84.8	84.8	0.0	0.0	82.8	0.5	-3.6	0.0	0.0	0.0	0.0	-0.0	5.1	5.1
2	359172.10	4889551.06	184.50	0	125	90.9	90.9	0.0	0.0	82.8	1.6	1.6	0.0	0.0	0.0	0.0	-0.0	4.8	4.8
3	359172.10	4889551.06	184.50	0	250	97.6	97.6	0.0	0.0	82.8	4.1	-0.1	0.0	0.0	0.0	0.0	-0.0	10.8	10.8
4	359172.10	4889551.06	184.50	0	500	98.2	98.2	0.0	0.0	82.8	7.5	-1.1	0.0	0.0	0.0	0.0	-0.0	8.9	8.9
5	359172.10	4889551.06	184.50	0	1000	98.8	98.8	0.0	0.0	82.8	14.3	-1.1	0.0	0.0	0.0	0.0	-0.0	2.7	2.7
6	359172.10	4889551.06	184.50	0	2000	95.6	95.6	0.0	0.0	82.8	37.8	-1.1	0.0	0.0	0.0	0.0	-0.0	-24.0	-24.0
7	359172.10	4889551.06	184.50	0	4000	84.1	84.1	0.0	0.0	82.8	128.2	-1.1	0.0	0.0	0.0	0.0	-0.0	-125.9	-125.9
8	359172.10	4889551.06	184.50	0	8000	65.6	65.6	0.0	0.0	82.8	457.4	-1.1	0.0	0.0	0.0	0.0	-0.0	-473.5	-473.5

Point Source, ISO 9613, Name: "(untitled)", ID: "S03"

Nr.	X (m)	Y (m)	Z (m)	Refl.	Freq. (Hz)	LxT dB(A)	LxN dB(A)	K0 (dB)	Dc (dB)	Adiv (dB)	Aatm (dB)	Agr (dB)	Afol (dB)	Ahous (dB)	Abar (dB)	Cmet (dB)	RL (dB)	LrT dB(A)	LrN dB(A)
1	361257.04	4887433.92	183.20	0	63	84.6	84.6	0.0	0.0	71.1	0.1	-3.0	0.0	0.0	0.0	0.0	-0.0	16.4	16.4
2	361257.04	4887433.92	183.20	0	125	92.4	92.4	0.0	0.0	71.1	0.4	1.8	0.0	0.0	0.0	0.0	-0.0	19.1	19.1
3	361257.04	4887433.92	183.20	0	250	97.6	97.6	0.0	0.0	71.1	1.1	0.1	0.0	0.0	0.0	0.0	-0.0	25.4	25.4
4	361257.04	4887433.92	183.20	0	500	99.4	99.4	0.0	0.0	71.1	2.0	-0.9	0.0	0.0	0.0	0.0	-0.0	27.2	27.2
5	361257.04	4887433.92	183.20	0	1000	100.3	100.3	0.0	0.0	71.1	3.7	-0.9	0.0	0.0	0.0	0.0	-0.0	26.4	26.4
6	361257.04	4887433.92	183.20	0	2000	95.9	95.9	0.0	0.0	71.1	9.8	-0.9	0.0	0.0	0.0	0.0	-0.0	15.9	15.9
7	361257.04	4887433.92	183.20	0	4000	86.1	86.1	0.0	0.0	71.1	33.2	-0.9	0.0	0.0	0.0	0.0	-0.0	-17.4	-17.4
8	361257.04	4887433.92	183.20	0	8000	68.1	68.1	0.0	0.0	71.1	118.5	-0.9	0.0	0.0	0.0	0.0	-0.0	-120.7	-120.7

Point Source, ISO 9613, Name: "(untitled)", ID: "S04"

Nr.	X (m)	Y (m)	Z (m)	Refl.	Freq. (Hz)	LxT dB(A)	LxN dB(A)	K0 (dB)	Dc (dB)	Adiv (dB)	Aatm (dB)	Agr (dB)	Afol (dB)	Ahous (dB)	Abar (dB)	Cmet (dB)	RL (dB)	LrT dB(A)	LrN dB(A)
1	360408.29	4890076.32	184.50	0	63	84.6	84.6	0.0	0.0	81.9	0.4	-3.3	0.0	0.0	0.0	0.0	-0.0	5.6	5.6
2	360408.29	4890076.32	184.50	0	125	92.4	92.4	0.0	0.0	81.9	1.4	1.7	0.0	0.0	0.0	0.0	-0.0	7.4	7.4
3	360408.29	4890076.32	184.50	0	250	97.6	97.6	0.0	0.0	81.9	3.6	-0.0	0.0	0.0	0.0	0.0	-0.0	12.1	12.1
4	360408.29	4890076.32	184.50	0	500	99.4	99.4	0.0	0.0	81.9	6.7	-1.0	0.0	0.0	0.0	0.0	-0.0	11.8	11.8
5	360408.29	4890076.32	184.50	0	1000	100.3	100.3	0.0	0.0	81.9	12.8	-1.0	0.0	0.0	0.0	0.0	-0.0	6.6	6.6
6	360408.29	4890076.32	184.50	0	2000	95.9	95.9	0.0	0.0	81.9	33.8	-1.0	0.0	0.0	0.0	0.0	-0.0	-18.8	-18.8
7	360408.29	4890076.32	184.50	0	4000	86.1	86.1	0.0	0.0	81.9	114.6	-1.0	0.0	0.0	0.0	0.0	-0.0	-109.4	-109.4
8	360408.29	4890076.32	184.50	0	8000	68.1	68.1	0.0	0.0	81.9	408.8	-1.0	0.0	0.0	0.0	0.0	-0.0	-421.6	-421.6

Point Source, ISO 9613, Name: "(untitled)", ID: "S05"

Nr.	X (m)	Y (m)	Z (m)	Refl.	Freq. (Hz)	LxT dB(A)	LxN dB(A)	K0 (dB)	Dc (dB)	Adiv (dB)	Aatm (dB)	Agr (dB)	Afol (dB)	Ahous (dB)	Abar (dB)	Cmet (dB)	RL (dB)	LrT dB(A)	LrN dB(A)
1	362668.00	4888881.21	179.50	0	63	84.6	84.6	0.0	0.0	76.4	0.2	-3.0	0.0	0.0	0.0	0.0	-0.0	10.9	10.9
2	362668.00	4888881.21	179.50	0	125	92.4	92.4	0.0	0.0	76.4	0.8	1.8	0.0	0.0	0.0	0.0	-0.0	13.4	13.4
3	362668.00	4888881.21	179.50	0	250	97.6	97.6	0.0	0.0	76.4	2.0	0.1	0.0	0.0	0.0	0.0	-0.0	19.2	19.2
4	362668.00	4888881.21	179.50	0	500	99.4	99.4	0.0	0.0	76.4	3.6	-0.9	0.0	0.0	0.0	0.0	-0.0	20.3	20.3

Point Source, ISO 9613, Name: "(untitled)", ID: "S05"																			
Nr.	X	Y	Z	Refl.	Freq.	LxT	LxN	K0	Dc	Adiv	Aatm	Agr	Afol	Ahous	Abar	Cmet	RL	LrT	LrN
	(m)	(m)	(m)		(Hz)	dB(A)	dB(A)	(dB)	(dB)	(dB)	(dB)	(dB)	(dB)	(dB)	(dB)	(dB)	(dB)	dB(A)	dB(A)
5	362668.00	4888881.21	179.50	0	1000	100.3	100.3	0.0	0.0	76.4	6.8	-0.9	0.0	0.0	0.0	0.0	-0.0	17.9	17.9
6	362668.00	4888881.21	179.50	0	2000	95.9	95.9	0.0	0.0	76.4	18.1	-0.9	0.0	0.0	0.0	0.0	-0.0	2.3	2.3
7	362668.00	4888881.21	179.50	0	4000	86.1	86.1	0.0	0.0	76.4	61.2	-0.9	0.0	0.0	0.0	0.0	-0.0	-50.7	-50.7
8	362668.00	4888881.21	179.50	0	8000	68.1	68.1	0.0	0.0	76.4	218.4	-0.9	0.0	0.0	0.0	0.0	-0.0	-225.8	-225.8

Point Source, ISO 9613, Name: "(untitled)", ID: "S06"																			
Nr.	X	Y	Z	Refl.	Freq.	LxT	LxN	K0	Dc	Adiv	Aatm	Agr	Afol	Ahous	Abar	Cmet	RL	LrT	LrN
	(m)	(m)	(m)		(Hz)	dB(A)	dB(A)	(dB)	(dB)	(dB)	(dB)	(dB)	(dB)	(dB)	(dB)	(dB)	(dB)	dB(A)	dB(A)
1	363743.45	4891454.22	184.50	0	63	84.8	84.8	0.0	0.0	84.3	0.6	-4.0	0.0	0.0	0.0	0.0	-0.0	3.9	3.9
2	363743.45	4891454.22	184.50	0	125	90.9	90.9	0.0	0.0	84.3	1.9	1.5	0.0	0.0	0.0	0.0	-0.0	3.2	3.2
3	363743.45	4891454.22	184.50	0	250	97.6	97.6	0.0	0.0	84.3	4.8	-0.2	0.0	0.0	0.0	0.0	-0.0	8.6	8.6
4	363743.45	4891454.22	184.50	0	500	98.2	98.2	0.0	0.0	84.3	9.0	-1.2	0.0	0.0	0.0	0.0	-0.0	6.1	6.1
5	363743.45	4891454.22	184.50	0	1000	98.8	98.8	0.0	0.0	84.3	17.0	-1.2	0.0	0.0	0.0	0.0	-0.0	-1.3	-1.3
6	363743.45	4891454.22	184.50	0	2000	95.6	95.6	0.0	0.0	84.3	44.9	-1.2	0.0	0.0	0.0	0.0	-0.0	-32.4	-32.4
7	363743.45	4891454.22	184.50	0	4000	84.1	84.1	0.0	0.0	84.3	152.2	-1.2	0.0	0.0	0.0	0.0	-0.0	-151.2	-151.2
8	363743.45	4891454.22	184.50	0	8000	65.6	65.6	0.0	0.0	84.3	542.9	-1.2	0.0	0.0	0.0	0.0	-0.0	-560.4	-560.4

Point Source, ISO 9613, Name: "(untitled)", ID: "S08"																			
Nr.	X	Y	Z	Refl.	Freq.	LxT	LxN	K0	Dc	Adiv	Aatm	Agr	Afol	Ahous	Abar	Cmet	RL	LrT	LrN
	(m)	(m)	(m)		(Hz)	dB(A)	dB(A)	(dB)	(dB)	(dB)	(dB)	(dB)	(dB)	(dB)	(dB)	(dB)	(dB)	dB(A)	dB(A)
1	359618.44	4887487.31	179.50	0	63	84.6	84.6	0.0	0.0	79.3	0.3	-3.0	0.0	0.0	0.0	0.0	-0.0	7.9	7.9
2	359618.44	4887487.31	179.50	0	125	92.4	92.4	0.0	0.0	79.3	1.1	1.8	0.0	0.0	0.0	0.0	-0.0	10.2	10.2
3	359618.44	4887487.31	179.50	0	250	97.6	97.6	0.0	0.0	79.3	2.7	0.1	0.0	0.0	0.0	0.0	-0.0	15.4	15.4
4	359618.44	4887487.31	179.50	0	500	99.4	99.4	0.0	0.0	79.3	5.0	-0.9	0.0	0.0	0.0	0.0	-0.0	15.9	15.9
5	359618.44	4887487.31	179.50	0	1000	100.3	100.3	0.0	0.0	79.3	9.6	-0.9	0.0	0.0	0.0	0.0	-0.0	12.3	12.3
6	359618.44	4887487.31	179.50	0	2000	95.9	95.9	0.0	0.0	79.3	25.3	-0.9	0.0	0.0	0.0	0.0	-0.0	-7.8	-7.8
7	359618.44	4887487.31	179.50	0	4000	86.1	86.1	0.0	0.0	79.3	85.7	-0.9	0.0	0.0	0.0	0.0	-0.0	-78.1	-78.1
8	359618.44	4887487.31	179.50	0	8000	68.1	68.1	0.0	0.0	79.3	305.8	-0.9	0.0	0.0	0.0	0.0	-0.0	-316.2	-316.2

Point Source, ISO 9613, Name: "(untitled)", ID: "S09"																			
Nr.	X	Y	Z	Refl.	Freq.	LxT	LxN	K0	Dc	Adiv	Aatm	Agr	Afol	Ahous	Abar	Cmet	RL	LrT	LrN
	(m)	(m)	(m)		(Hz)	dB(A)	dB(A)	(dB)	(dB)	(dB)	(dB)	(dB)	(dB)	(dB)	(dB)	(dB)	(dB)	dB(A)	dB(A)
1	360950.66	4887103.68	179.50	0	63	84.8	84.8	0.0	0.0	73.0	0.2	-3.0	0.0	0.0	0.0	0.0	-0.0	14.7	14.7
2	360950.66	4887103.68	179.50	0	125	90.9	90.9	0.0	0.0	73.0	0.5	1.8	0.0	0.0	0.0	0.0	-0.0	15.7	15.7
3	360950.66	4887103.68	179.50	0	250	97.6	97.6	0.0	0.0	73.0	1.3	0.1	0.0	0.0	0.0	0.0	-0.0	23.3	23.3
4	360950.66	4887103.68	179.50	0	500	98.2	98.2	0.0	0.0	73.0	2.4	-0.9	0.0	0.0	0.0	0.0	-0.0	23.7	23.7
5	360950.66	4887103.68	179.50	0	1000	98.8	98.8	0.0	0.0	73.0	4.6	-0.9	0.0	0.0	0.0	0.0	-0.0	22.2	22.2
6	360950.66	4887103.68	179.50	0	2000	95.6	95.6	0.0	0.0	73.0	12.1	-0.9	0.0	0.0	0.0	0.0	-0.0	11.4	11.4
7	360950.66	4887103.68	179.50	0	4000	84.1	84.1	0.0	0.0	73.0	41.1	-0.9	0.0	0.0	0.0	0.0	-0.0	-29.0	-29.0
8	360950.66	4887103.68	179.50	0	8000	65.6	65.6	0.0	0.0	73.0	146.5	-0.9	0.0	0.0	0.0	0.0	-0.0	-153.0	-153.0

Point Source, ISO 9613, Name: "(untitled)", ID: "S10"																			
Nr.	X	Y	Z	Refl.	Freq.	LxT	LxN	K0	Dc	Adiv	Aatm	Agr	Afol	Ahous	Abar	Cmet	RL	LrT	LrN
	(m)	(m)	(m)		(Hz)	dB(A)	dB(A)	(dB)	(dB)	(dB)	(dB)	(dB)	(dB)	(dB)	(dB)	(dB)	(dB)	dB(A)	dB(A)
1	359083.40	4887184.13	183.07	0	63	84.6	84.6	0.0	0.0	80.9	0.4	-3.0	0.0	0.0	0.0	0.0	-0.0	6.3	6.3
2	359083.40	4887184.13	183.07	0	125	92.4	92.4	0.0	0.0	80.9	1.3	1.8	0.0	0.0	0.0	0.0	-0.0	8.5	8.5
3	359083.40	4887184.13	183.07	0	250	97.6	97.6	0.0	0.0	80.9	3.3	0.1	0.0	0.0	0.0	0.0	-0.0	13.4	13.4
4	359083.40	4887184.13	183.07	0	500	99.4	99.4	0.0	0.0	80.9	6.0	-0.9	0.0	0.0	0.0	0.0	-0.0	13.4	13.4
5	359083.40	4887184.13	183.07	0	1000	100.3	100.3	0.0	0.0	80.9	11.4	-0.9	0.0	0.0	0.0	0.0	-0.0	8.9	8.9
6	359083.40	4887184.13	183.07	0	2000	95.9	95.9	0.0	0.0	80.9	30.2	-0.9	0.0	0.0	0.0	0.0	-0.0	-14.2	-14.2
7	359083.40	4887184.13	183.07	0	4000	86.1	86.1	0.0	0.0	80.9	102.3	-0.9	0.0	0.0	0.0	0.0	-0.0	-96.1	-96.1
8	359083.40	4887184.13	183.07	0	8000	68.1	68.1	0.0	0.0	80.9	364.7	-0.9	0.0	0.0	0.0	0.0	-0.0	-376.6	-376.6

Point Source, ISO 9613, Name: "(untitled)", ID: "S11"																			
Nr.	X	Y	Z	Refl.	Freq.	LxT	LxN	K0	Dc	Adiv	Aatm	Agr	Afol	Ahous	Abar	Cmet	RL	LrT	LrN
	(m)	(m)	(m)		(Hz)	dB(A)	dB(A)	(dB)	(dB)	(dB)	(dB)	(dB)	(dB)	(dB)	(dB)	(dB)	(dB)	dB(A)	dB(A)
1	361640.50	4887205.50	182.57	0	63	84.8	84.8	0.0	0.0	66.3	0.1	-3.0	0.0	0.0	0.0	0.0	-0.0	21.4	21.4
2	361640.50	4887205.50	182.57	0	125	90.9	90.9	0.0	0.0	66.3	0.2	1.5	0.0	0.0	0.0	0.0	-0.0	22.8	22.8
3	361640.50	4887205.50	182.57	0	250	97.6	97.6	0.0	0.0	66.3	0.6	0.1	0.0	0.0	0.0	0.0	-0.0	30.6	30.6
4	361640.50	4887205.50	182.57	0	500	98.2	98.2	0.0	0.0	66.3	1.1	-0.9	0.0	0.0	0.0	0.0	-0.0	31.7	31.7
5	361640.50	4887205.50	182.57	0	1000	98.8	98.8	0.0	0.0	66.3	2.1	-0.9	0.0	0.0	0.0	0.0	-0.0	31.3	31.3
6	361640.50	4887205.50	182.57	0	2000	95.6	95.6	0.0	0.0	66.3	5.6	-0.9	0.0	0.0	0.0	0.0	-0.0	24.6	24.6
7	361640.50	4887205.50	182.57	0	4000	84.1	84.1	0.0	0.0	66.3	19.1	-0.9	0.0	0.0	0.0	0.0	-0.0	-0.4	-0.4

Point Source, ISO 9613, Name: "(untitled)", ID: "S11"																			
Nr.	X	Y	Z	Refl.	Freq.	LxT	LxN	K0	Dc	Adiv	Aatm	Agr	Afol	Ahous	Abar	Cmet	RL	LrT	LrN
	(m)	(m)	(m)		(Hz)	dB(A)	dB(A)	(dB)	(dB)	(dB)	(dB)	(dB)	(dB)	(dB)	(dB)	(dB)	(dB)	dB(A)	dB(A)
8	361640.50	4887205.50	182.57	0	8000	65.6	65.6	0.0	0.0	66.3	68.2	-0.9	0.0	0.0	0.0	0.0	-0.0	-68.0	-68.0

Point Source, ISO 9613, Name: "(untitled)", ID: "S16"																			
Nr.	X	Y	Z	Refl.	Freq.	LxT	LxN	K0	Dc	Adiv	Aatm	Agr	Afol	Ahous	Abar	Cmet	RL	LrT	LrN
	(m)	(m)	(m)		(Hz)	dB(A)	dB(A)	(dB)	(dB)	(dB)	(dB)	(dB)	(dB)	(dB)	(dB)	(dB)	(dB)	dB(A)	dB(A)
1	361904.36	4889060.36	181.21	0	63	84.6	84.6	0.0	0.0	77.1	0.2	-3.0	0.0	0.0	0.0	0.0	-0.0	10.3	10.3
2	361904.36	4889060.36	181.21	0	125	92.4	92.4	0.0	0.0	77.1	0.8	1.8	0.0	0.0	0.0	0.0	-0.0	12.7	12.7
3	361904.36	4889060.36	181.21	0	250	97.6	97.6	0.0	0.0	77.1	2.1	0.1	0.0	0.0	0.0	0.0	-0.0	18.4	18.4
4	361904.36	4889060.36	181.21	0	500	99.4	99.4	0.0	0.0	77.1	3.9	-0.9	0.0	0.0	0.0	0.0	-0.0	19.4	19.4
5	361904.36	4889060.36	181.21	0	1000	100.3	100.3	0.0	0.0	77.1	7.3	-0.9	0.0	0.0	0.0	0.0	-0.0	16.8	16.8
6	361904.36	4889060.36	181.21	0	2000	95.9	95.9	0.0	0.0	77.1	19.4	-0.9	0.0	0.0	0.0	0.0	-0.0	0.3	0.3
7	361904.36	4889060.36	181.21	0	4000	86.1	86.1	0.0	0.0	77.1	65.9	-0.9	0.0	0.0	0.0	0.0	-0.0	-55.9	-55.9
8	361904.36	4889060.36	181.21	0	8000	68.1	68.1	0.0	0.0	77.1	234.9	-0.9	0.0	0.0	0.0	0.0	-0.0	-243.0	-243.0

Point Source, ISO 9613, Name: "(untitled)", ID: "S17"																			
Nr.	X	Y	Z	Refl.	Freq.	LxT	LxN	K0	Dc	Adiv	Aatm	Agr	Afol	Ahous	Abar	Cmet	RL	LrT	LrN
	(m)	(m)	(m)		(Hz)	dB(A)	dB(A)	(dB)	(dB)	(dB)	(dB)	(dB)	(dB)	(dB)	(dB)	(dB)	(dB)	dB(A)	dB(A)
1	358685.05	4887301.99	179.50	0	63	84.6	84.6	0.0	0.0	81.9	0.4	-3.3	0.0	0.0	0.0	0.0	-0.0	5.6	5.6
2	358685.05	4887301.99	179.50	0	125	92.4	92.4	0.0	0.0	81.9	1.5	1.7	0.0	0.0	0.0	0.0	-0.0	7.3	7.3
3	358685.05	4887301.99	179.50	0	250	97.6	97.6	0.0	0.0	81.9	3.7	-0.0	0.0	0.0	0.0	0.0	-0.0	12.0	12.0
4	358685.05	4887301.99	179.50	0	500	99.4	99.4	0.0	0.0	81.9	6.8	-1.0	0.0	0.0	0.0	0.0	-0.0	11.7	11.7
5	358685.05	4887301.99	179.50	0	1000	100.3	100.3	0.0	0.0	81.9	12.9	-1.0	0.0	0.0	0.0	0.0	-0.0	6.5	6.5
6	358685.05	4887301.99	179.50	0	2000	95.9	95.9	0.0	0.0	81.9	34.0	-1.0	0.0	0.0	0.0	0.0	-0.0	-19.1	-19.1
7	358685.05	4887301.99	179.50	0	4000	86.1	86.1	0.0	0.0	81.9	115.5	-1.0	0.0	0.0	0.0	0.0	-0.0	-110.3	-110.3
8	358685.05	4887301.99	179.50	0	8000	68.1	68.1	0.0	0.0	81.9	411.9	-1.0	0.0	0.0	0.0	0.0	-0.0	-424.7	-424.7

Point Source, ISO 9613, Name: "(untitled)", ID: "S19"																			
Nr.	X	Y	Z	Refl.	Freq.	LxT	LxN	K0	Dc	Adiv	Aatm	Agr	Afol	Ahous	Abar	Cmet	RL	LrT	LrN
	(m)	(m)	(m)		(Hz)	dB(A)	dB(A)	(dB)	(dB)	(dB)	(dB)	(dB)	(dB)	(dB)	(dB)	(dB)	(dB)	dB(A)	dB(A)
1	365107.18	4889563.44	184.50	0	63	84.8	84.8	0.0	0.0	82.7	0.5	-3.5	0.0	0.0	0.0	0.0	-0.0	5.2	5.2
2	365107.18	4889563.44	184.50	0	125	90.9	90.9	0.0	0.0	82.7	1.6	1.6	0.0	0.0	0.0	0.0	-0.0	5.0	5.0
3	365107.18	4889563.44	184.50	0	250	97.6	97.6	0.0	0.0	82.7	4.0	-0.1	0.0	0.0	0.0	0.0	-0.0	11.0	11.0
4	365107.18	4889563.44	184.50	0	500	98.2	98.2	0.0	0.0	82.7	7.4	-1.1	0.0	0.0	0.0	0.0	-0.0	9.2	9.2
5	365107.18	4889563.44	184.50	0	1000	98.8	98.8	0.0	0.0	82.7	14.0	-1.1	0.0	0.0	0.0	0.0	-0.0	3.2	3.2
6	365107.18	4889563.44	184.50	0	2000	95.6	95.6	0.0	0.0	82.7	37.0	-1.1	0.0	0.0	0.0	0.0	-0.0	-23.0	-23.0
7	365107.18	4889563.44	184.50	0	4000	84.1	84.1	0.0	0.0	82.7	125.4	-1.1	0.0	0.0	0.0	0.0	-0.0	-122.9	-122.9
8	365107.18	4889563.44	184.50	0	8000	65.6	65.6	0.0	0.0	82.7	447.4	-1.1	0.0	0.0	0.0	0.0	-0.0	-463.4	-463.4

Point Source, ISO 9613, Name: "(untitled)", ID: "S20"																			
Nr.	X	Y	Z	Refl.	Freq.	LxT	LxN	K0	Dc	Adiv	Aatm	Agr	Afol	Ahous	Abar	Cmet	RL	LrT	LrN
	(m)	(m)	(m)		(Hz)	dB(A)	dB(A)	(dB)	(dB)	(dB)	(dB)	(dB)	(dB)	(dB)	(dB)	(dB)	(dB)	dB(A)	dB(A)
1	362894.06	4889249.14	183.86	0	63	84.6	84.6	0.0	0.0	78.2	0.3	-3.0	0.0	0.0	0.0	0.0	-0.0	9.2	9.2
2	362894.06	4889249.14	183.86	0	125	92.4	92.4	0.0	0.0	78.2	0.9	1.8	0.0	0.0	0.0	0.0	-0.0	11.5	11.5
3	362894.06	4889249.14	183.86	0	250	97.6	97.6	0.0	0.0	78.2	2.4	0.1	0.0	0.0	0.0	0.0	-0.0	17.0	17.0
4	362894.06	4889249.14	183.86	0	500	99.4	99.4	0.0	0.0	78.2	4.4	-0.9	0.0	0.0	0.0	0.0	-0.0	17.7	17.7
5	362894.06	4889249.14	183.86	0	1000	100.3	100.3	0.0	0.0	78.2	8.4	-0.9	0.0	0.0	0.0	0.0	-0.0	14.7	14.7
6	362894.06	4889249.14	183.86	0	2000	95.9	95.9	0.0	0.0	78.2	22.1	-0.9	0.0	0.0	0.0	0.0	-0.0	-3.4	-3.4
7	362894.06	4889249.14	183.86	0	4000	86.1	86.1	0.0	0.0	78.2	74.9	-0.9	0.0	0.0	0.0	0.0	-0.0	-66.0	-66.0
8	362894.06	4889249.14	183.86	0	8000	68.1	68.1	0.0	0.0	78.2	267.0	-0.9	0.0	0.0	0.0	0.0	-0.0	-276.2	-276.2

Point Source, ISO 9613, Name: "(untitled)", ID: "S21"																			
Nr.	X	Y	Z	Refl.	Freq.	LxT	LxN	K0	Dc	Adiv	Aatm	Agr	Afol	Ahous	Abar	Cmet	RL	LrT	LrN
	(m)	(m)	(m)		(Hz)	dB(A)	dB(A)	(dB)	(dB)	(dB)	(dB)	(dB)	(dB)	(dB)	(dB)	(dB)	(dB)	dB(A)	dB(A)
1	364880.81	4889038.86	180.18	0	63	84.8	84.8	0.0	0.0	81.4	0.4	-3.2	0.0	0.0	0.0	0.0	-0.0	6.1	6.1
2	364880.81	4889038.86	180.18	0	125	90.9	90.9	0.0	0.0	81.4	1.4	1.7	0.0	0.0	0.0	0.0	-0.0	6.4	6.4
3	364880.81	4889038.86	180.18	0	250	97.6	97.6	0.0	0.0	81.4	3.5	0.0	0.0	0.0	0.0	0.0	-0.0	12.7	12.7
4	364880.81	4889038.86	180.18	0	500	98.2	98.2	0.0	0.0	81.4	6.4	-1.0	0.0	0.0	0.0	0.0	-0.0	11.3	11.3
5	364880.81	4889038.86	180.18	0	1000	98.8	98.8	0.0	0.0	81.4	12.2	-1.0	0.0	0.0	0.0	0.0	-0.0	6.2	6.2
6	364880.81	4889038.86	180.18	0	2000	95.6	95.6	0.0	0.0	81.4	32.1	-1.0	0.0	0.0	0.0	0.0	-0.0	-17.0	-17.0
7	364880.81	4889038.86	180.18	0	4000	84.1	84.1	0.0	0.0	81.4	108.9	-1.0	0.0	0.0	0.0	0.0	-0.0	-105.3	-105.3
8	364880.81	4889038.86	180.18	0	8000	65.6	65.6	0.0	0.0	81.4	388.6	-1.0	0.0	0.0	0.0	0.0	-0.0	-403.4	-403.4

Point Source, ISO 9613, Name: "(untitled)", ID: "S22"																			
Nr.	X	Y	Z	Refl.	Freq.	LxT	LxN	K0	Dc	Adiv	Aatm	Agr	Afol	Ahous	Abar	Cmet	RL	LrT	LrN
	(m)	(m)	(m)		(Hz)	dB(A)	dB(A)	(dB)	(dB)	(dB)	(dB)	(dB)	(dB)	(dB)	(dB)	(dB)	(dB)	dB(A)	dB(A)
1	361447.08	4890656.10	189.50	0	63	84.6	84.6	0.0	0.0	82.3	0.5	-3.4	0.0	0.0	0.0	0.0	-0.0	5.3	5.3
2	361447.08	4890656.10	189.50	0	125	92.4	92.4	0.0	0.0	82.3	1.5	1.7	0.0	0.0	0.0	0.0	-0.0	7.0	7.0
3	361447.08	4890656.10	189.50	0	250	97.6	97.6	0.0	0.0	82.3	3.8	-0.1	0.0	0.0	0.0	0.0	-0.0	11.6	11.6
4	361447.08	4890656.10	189.50	0	500	99.4	99.4	0.0	0.0	82.3	7.1	-1.0	0.0	0.0	0.0	0.0	-0.0	11.1	11.1
5	361447.08	4890656.10	189.50	0	1000	100.3	100.3	0.0	0.0	82.3	13.4	-1.0	0.0	0.0	0.0	0.0	-0.0	5.7	5.7
6	361447.08	4890656.10	189.50	0	2000	95.9	95.9	0.0	0.0	82.3	35.4	-1.0	0.0	0.0	0.0	0.0	-0.0	-20.7	-20.7
7	361447.08	4890656.10	189.50	0	4000	86.1	86.1	0.0	0.0	82.3	120.0	-1.0	0.0	0.0	0.0	0.0	-0.0	-115.1	-115.1
8	361447.08	4890656.10	189.50	0	8000	68.1	68.1	0.0	0.0	82.3	427.9	-1.0	0.0	0.0	0.0	0.0	-0.0	-441.1	-441.1

Point Source, ISO 9613, Name: "(untitled)", ID: "S23"																			
Nr.	X	Y	Z	Refl.	Freq.	LxT	LxN	K0	Dc	Adiv	Aatm	Agr	Afol	Ahous	Abar	Cmet	RL	LrT	LrN
	(m)	(m)	(m)		(Hz)	dB(A)	dB(A)	(dB)	(dB)	(dB)	(dB)	(dB)	(dB)	(dB)	(dB)	(dB)	(dB)	dB(A)	dB(A)
1	361586.36	4888695.72	179.50	0	63	84.6	84.6	0.0	0.0	75.8	0.2	-3.0	0.0	0.0	0.0	0.0	-0.0	11.6	11.6
2	361586.36	4888695.72	179.50	0	125	92.4	92.4	0.0	0.0	75.8	0.7	1.8	0.0	0.0	0.0	0.0	-0.0	14.1	14.1
3	361586.36	4888695.72	179.50	0	250	97.6	97.6	0.0	0.0	75.8	1.8	0.1	0.0	0.0	0.0	0.0	-0.0	19.9	19.9
4	361586.36	4888695.72	179.50	0	500	99.4	99.4	0.0	0.0	75.8	3.3	-0.9	0.0	0.0	0.0	0.0	-0.0	21.2	21.2
5	361586.36	4888695.72	179.50	0	1000	100.3	100.3	0.0	0.0	75.8	6.3	-0.9	0.0	0.0	0.0	0.0	-0.0	19.1	19.1
6	361586.36	4888695.72	179.50	0	2000	95.9	95.9	0.0	0.0	75.8	16.8	-0.9	0.0	0.0	0.0	0.0	-0.0	4.2	4.2
7	361586.36	4888695.72	179.50	0	4000	86.1	86.1	0.0	0.0	75.8	56.9	-0.9	0.0	0.0	0.0	0.0	-0.0	-45.7	-45.7
8	361586.36	4888695.72	179.50	0	8000	68.1	68.1	0.0	0.0	75.8	202.9	-0.9	0.0	0.0	0.0	0.0	-0.0	-209.7	-209.7

Point Source, ISO 9613, Name: "(untitled)", ID: "S25"																			
Nr.	X	Y	Z	Refl.	Freq.	LxT	LxN	K0	Dc	Adiv	Aatm	Agr	Afol	Ahous	Abar	Cmet	RL	LrT	LrN
	(m)	(m)	(m)		(Hz)	dB(A)	dB(A)	(dB)	(dB)	(dB)	(dB)	(dB)	(dB)	(dB)	(dB)	(dB)	(dB)	dB(A)	dB(A)
1	360694.00	4888127.50	179.50	0	63	84.6	84.6	0.0	0.0	76.3	0.2	-3.0	0.0	0.0	0.0	0.0	-0.0	11.1	11.1
2	360694.00	4888127.50	179.50	0	125	92.4	92.4	0.0	0.0	76.3	0.8	1.8	0.0	0.0	0.0	0.0	-0.0	13.6	13.6
3	360694.00	4888127.50	179.50	0	250	97.6	97.6	0.0	0.0	76.3	1.9	0.1	0.0	0.0	0.0	0.0	-0.0	19.3	19.3
4	360694.00	4888127.50	179.50	0	500	99.4	99.4	0.0	0.0	76.3	3.5	-0.9	0.0	0.0	0.0	0.0	-0.0	20.4	20.4
5	360694.00	4888127.50	179.50	0	1000	100.3	100.3	0.0	0.0	76.3	6.7	-0.9	0.0	0.0	0.0	0.0	-0.0	18.2	18.2
6	360694.00	4888127.50	179.50	0	2000	95.9	95.9	0.0	0.0	76.3	17.8	-0.9	0.0	0.0	0.0	0.0	-0.0	2.7	2.7
7	360694.00	4888127.50	179.50	0	4000	86.1	86.1	0.0	0.0	76.3	60.3	-0.9	0.0	0.0	0.0	0.0	-0.0	-49.6	-49.6
8	360694.00	4888127.50	179.50	0	8000	68.1	68.1	0.0	0.0	76.3	215.1	-0.9	0.0	0.0	0.0	0.0	-0.0	-222.4	-222.4

Point Source, ISO 9613, Name: "(untitled)", ID: "S27"																			
Nr.	X	Y	Z	Refl.	Freq.	LxT	LxN	K0	Dc	Adiv	Aatm	Agr	Afol	Ahous	Abar	Cmet	RL	LrT	LrN
	(m)	(m)	(m)		(Hz)	dB(A)	dB(A)	(dB)	(dB)	(dB)	(dB)	(dB)	(dB)	(dB)	(dB)	(dB)	(dB)	dB(A)	dB(A)
1	365916.00	4890146.00	185.29	0	63	84.6	84.6	0.0	0.0	84.7	0.6	-4.1	0.0	0.0	0.0	0.0	-0.0	3.4	3.4
2	365916.00	4890146.00	185.29	0	125	92.4	92.4	0.0	0.0	84.7	2.0	1.5	0.0	0.0	0.0	0.0	-0.0	4.3	4.3
3	365916.00	4890146.00	185.29	0	250	97.6	97.6	0.0	0.0	84.7	5.0	-0.2	0.0	0.0	0.0	0.0	-0.0	8.2	8.2
4	365916.00	4890146.00	185.29	0	500	99.4	99.4	0.0	0.0	84.7	9.3	-1.2	0.0	0.0	0.0	0.0	-0.0	6.7	6.7
5	365916.00	4890146.00	185.29	0	1000	100.3	100.3	0.0	0.0	84.7	17.6	-1.2	0.0	0.0	0.0	0.0	-0.0	-0.8	-0.8
6	365916.00	4890146.00	185.29	0	2000	95.9	95.9	0.0	0.0	84.7	46.6	-1.2	0.0	0.0	0.0	0.0	-0.0	-34.1	-34.1
7	365916.00	4890146.00	185.29	0	4000	86.1	86.1	0.0	0.0	84.7	158.0	-1.2	0.0	0.0	0.0	0.0	-0.0	-155.4	-155.4
8	365916.00	4890146.00	185.29	0	8000	68.1	68.1	0.0	0.0	84.7	563.6	-1.2	0.0	0.0	0.0	0.0	-0.0	-578.9	-578.9

Point Source, ISO 9613, Name: "(untitled)", ID: "S29"																			
Nr.	X	Y	Z	Refl.	Freq.	LxT	LxN	K0	Dc	Adiv	Aatm	Agr	Afol	Ahous	Abar	Cmet	RL	LrT	LrN
	(m)	(m)	(m)		(Hz)	dB(A)	dB(A)	(dB)	(dB)	(dB)	(dB)	(dB)	(dB)	(dB)	(dB)	(dB)	(dB)	dB(A)	dB(A)
1	359561.75	4889909.18	182.65	0	63	84.8	84.8	0.0	0.0	82.8	0.5	-3.6	0.0	0.0	0.0	0.0	-0.0	5.1	5.1
2	359561.75	4889909.18	182.65	0	125	90.9	90.9	0.0	0.0	82.8	1.6	1.6	0.0	0.0	0.0	0.0	-0.0	4.9	4.9
3	359561.75	4889909.18	182.65	0	250	97.6	97.6	0.0	0.0	82.8	4.0	-0.1	0.0	0.0	0.0	0.0	-0.0	10.9	10.9
4	359561.75	4889909.18	182.65	0	500	98.2	98.2	0.0	0.0	82.8	7.5	-1.1	0.0	0.0	0.0	0.0	-0.0	9.0	9.0
5	359561.75	4889909.18	182.65	0	1000	98.8	98.8	0.0	0.0	82.8	14.2	-1.1	0.0	0.0	0.0	0.0	-0.0	2.9	2.9
6	359561.75	4889909.18	182.65	0	2000	95.6	95.6	0.0	0.0	82.8	37.4	-1.1	0.0	0.0	0.0	0.0	-0.0	-23.5	-23.5
7	359561.75	4889909.18	182.65	0	4000	84.1	84.1	0.0	0.0	82.8	126.9	-1.1	0.0	0.0	0.0	0.0	-0.0	-124.5	-124.5
8	359561.75	4889909.18	182.65	0	8000	65.6	65.6	0.0	0.0	82.8	452.8	-1.1	0.0	0.0	0.0	0.0	-0.0	-468.9	-468.9

Point Source, ISO 9613, Name: "(untitled)", ID: "S31"																			
Nr.	X	Y	Z	Refl.	Freq.	LxT	LxN	K0	Dc	Adiv	Aatm	Agr	Afol	Ahous	Abar	Cmet	RL	LrT	LrN
	(m)	(m)	(m)		(Hz)	dB(A)	dB(A)	(dB)	(dB)	(dB)	(dB)	(dB)	(dB)	(dB)	(dB)	(dB)	(dB)	dB(A)	dB(A)
1	362343.14	4891028.43	189.50	0	63	84.8	84.8	0.0	0.0	83.0	0.5	-3.6	0.0	0.0	0.0	0.0	-0.0	5.0	5.0
2	362343.14	4891028.43	189.50	0	125	90.9	90.9	0.0	0.0	83.0	1.6	1.6	0.0	0.0	0.0	0.0	-0.0	4.7	4.7
3	362343.14	4891028.43	189.50	0	250	97.6	97.6	0.0	0.0	83.0	4.1	-0.1	0.0	0.0	0.0	0.0	-0.0	10.6	10.6

Point Source, ISO 9613, Name: "(untitled)", ID: "S31"																			
Nr.	X	Y	Z	Refl.	Freq.	LxT	LxN	K0	Dc	Adiv	Aatm	Agr	Afol	Ahous	Abar	Cmet	RL	LrT	LrN
	(m)	(m)	(m)		(Hz)	dB(A)	dB(A)	(dB)	(dB)	(dB)	(dB)	(dB)	(dB)	(dB)	(dB)	(dB)	(dB)	dB(A)	dB(A)
4	362343.14	4891028.43	189.50	0	500	98.2	98.2	0.0	0.0	83.0	7.6	-1.1	0.0	0.0	0.0	0.0	-0.0	8.7	8.7
5	362343.14	4891028.43	189.50	0	1000	98.8	98.8	0.0	0.0	83.0	14.5	-1.1	0.0	0.0	0.0	0.0	-0.0	2.5	2.5
6	362343.14	4891028.43	189.50	0	2000	95.6	95.6	0.0	0.0	83.0	38.3	-1.1	0.0	0.0	0.0	0.0	-0.0	-24.5	-24.5
7	362343.14	4891028.43	189.50	0	4000	84.1	84.1	0.0	0.0	83.0	129.7	-1.1	0.0	0.0	0.0	0.0	-0.0	-127.5	-127.5
8	362343.14	4891028.43	189.50	0	8000	65.6	65.6	0.0	0.0	83.0	462.6	-1.1	0.0	0.0	0.0	0.0	-0.0	-478.8	-478.8

Point Source, ISO 9613, Name: "(untitled)", ID: "S32"																			
Nr.	X	Y	Z	Refl.	Freq.	LxT	LxN	K0	Dc	Adiv	Aatm	Agr	Afol	Ahous	Abar	Cmet	RL	LrT	LrN
	(m)	(m)	(m)		(Hz)	dB(A)	dB(A)	(dB)	(dB)	(dB)	(dB)	(dB)	(dB)	(dB)	(dB)	(dB)	(dB)	dB(A)	dB(A)
1	359529.83	4887967.14	179.50	0	63	84.6	84.6	0.0	0.0	80.0	0.3	-3.0	0.0	0.0	0.0	0.0	-0.0	7.3	7.3
2	359529.83	4887967.14	179.50	0	125	92.4	92.4	0.0	0.0	80.0	1.2	1.8	0.0	0.0	0.0	0.0	-0.0	9.5	9.5
3	359529.83	4887967.14	179.50	0	250	97.6	97.6	0.0	0.0	80.0	2.9	0.1	0.0	0.0	0.0	0.0	-0.0	14.6	14.6
4	359529.83	4887967.14	179.50	0	500	99.4	99.4	0.0	0.0	80.0	5.4	-0.9	0.0	0.0	0.0	0.0	-0.0	14.9	14.9
5	359529.83	4887967.14	179.50	0	1000	100.3	100.3	0.0	0.0	80.0	10.3	-0.9	0.0	0.0	0.0	0.0	-0.0	10.9	10.9
6	359529.83	4887967.14	179.50	0	2000	95.9	95.9	0.0	0.0	80.0	27.2	-0.9	0.0	0.0	0.0	0.0	-0.0	-10.4	-10.4
7	359529.83	4887967.14	179.50	0	4000	86.1	86.1	0.0	0.0	80.0	92.3	-0.9	0.0	0.0	0.0	0.0	-0.0	-85.3	-85.3
8	359529.83	4887967.14	179.50	0	8000	68.1	68.1	0.0	0.0	80.0	329.3	-0.9	0.0	0.0	0.0	0.0	-0.0	-340.3	-340.3

Point Source, ISO 9613, Name: "(untitled)", ID: "S34"																			
Nr.	X	Y	Z	Refl.	Freq.	LxT	LxN	K0	Dc	Adiv	Aatm	Agr	Afol	Ahous	Abar	Cmet	RL	LrT	LrN
	(m)	(m)	(m)		(Hz)	dB(A)	dB(A)	(dB)	(dB)	(dB)	(dB)	(dB)	(dB)	(dB)	(dB)	(dB)	(dB)	dB(A)	dB(A)
1	363323.99	4889900.50	179.50	0	63	84.8	84.8	0.0	0.0	80.7	0.4	-3.0	0.0	0.0	0.0	0.0	-0.0	6.8	6.8
2	363323.99	4889900.50	179.50	0	125	90.9	90.9	0.0	0.0	80.7	1.3	1.8	0.0	0.0	0.0	0.0	-0.0	7.2	7.2
3	363323.99	4889900.50	179.50	0	250	97.6	97.6	0.0	0.0	80.7	3.2	0.1	0.0	0.0	0.0	0.0	-0.0	13.7	13.7
4	363323.99	4889900.50	179.50	0	500	98.2	98.2	0.0	0.0	80.7	5.9	-0.9	0.0	0.0	0.0	0.0	-0.0	12.6	12.6
5	363323.99	4889900.50	179.50	0	1000	98.8	98.8	0.0	0.0	80.7	11.1	-0.9	0.0	0.0	0.0	0.0	-0.0	7.9	7.9
6	363323.99	4889900.50	179.50	0	2000	95.6	95.6	0.0	0.0	80.7	29.4	-0.9	0.0	0.0	0.0	0.0	-0.0	-13.6	-13.6
7	363323.99	4889900.50	179.50	0	4000	84.1	84.1	0.0	0.0	80.7	99.7	-0.9	0.0	0.0	0.0	0.0	-0.0	-95.4	-95.4
8	363323.99	4889900.50	179.50	0	8000	65.6	65.6	0.0	0.0	80.7	355.6	-0.9	0.0	0.0	0.0	0.0	-0.0	-369.8	-369.8

Point Source, ISO 9613, Name: "(untitled)", ID: "S35"																			
Nr.	X	Y	Z	Refl.	Freq.	LxT	LxN	K0	Dc	Adiv	Aatm	Agr	Afol	Ahous	Abar	Cmet	RL	LrT	LrN
	(m)	(m)	(m)		(Hz)	dB(A)	dB(A)	(dB)	(dB)	(dB)	(dB)	(dB)	(dB)	(dB)	(dB)	(dB)	(dB)	dB(A)	dB(A)
1	361299.03	4888182.65	179.50	0	63	84.6	84.6	0.0	0.0	74.1	0.2	-3.0	0.0	0.0	0.0	0.0	-0.0	13.3	13.3
2	361299.03	4888182.65	179.50	0	125	92.4	92.4	0.0	0.0	74.1	0.6	1.8	0.0	0.0	0.0	0.0	-0.0	15.9	15.9
3	361299.03	4888182.65	179.50	0	250	97.6	97.6	0.0	0.0	74.1	1.5	0.1	0.0	0.0	0.0	0.0	-0.0	21.9	21.9
4	361299.03	4888182.65	179.50	0	500	99.4	99.4	0.0	0.0	74.1	2.8	-0.9	0.0	0.0	0.0	0.0	-0.0	23.4	23.4
5	361299.03	4888182.65	179.50	0	1000	100.3	100.3	0.0	0.0	74.1	5.2	-0.9	0.0	0.0	0.0	0.0	-0.0	21.9	21.9
6	361299.03	4888182.65	179.50	0	2000	95.9	95.9	0.0	0.0	74.1	13.8	-0.9	0.0	0.0	0.0	0.0	-0.0	8.9	8.9
7	361299.03	4888182.65	179.50	0	4000	86.1	86.1	0.0	0.0	74.1	46.9	-0.9	0.0	0.0	0.0	0.0	-0.0	-34.0	-34.0
8	361299.03	4888182.65	179.50	0	8000	68.1	68.1	0.0	0.0	74.1	167.3	-0.9	0.0	0.0	0.0	0.0	-0.0	-172.4	-172.4

Point Source, ISO 9613, Name: "(untitled)", ID: "S36"																			
Nr.	X	Y	Z	Refl.	Freq.	LxT	LxN	K0	Dc	Adiv	Aatm	Agr	Afol	Ahous	Abar	Cmet	RL	LrT	LrN
	(m)	(m)	(m)		(Hz)	dB(A)	dB(A)	(dB)	(dB)	(dB)	(dB)	(dB)	(dB)	(dB)	(dB)	(dB)	(dB)	dB(A)	dB(A)
1	364588.58	4888397.36	178.68	0	63	84.6	84.6	0.0	0.0	79.7	0.3	-3.0	0.0	0.0	0.0	0.0	-0.0	7.5	7.5
2	364588.58	4888397.36	178.68	0	125	92.4	92.4	0.0	0.0	79.7	1.1	1.8	0.0	0.0	0.0	0.0	-0.0	9.8	9.8
3	364588.58	4888397.36	178.68	0	250	97.6	97.6	0.0	0.0	79.7	2.8	0.1	0.0	0.0	0.0	0.0	-0.0	15.0	15.0
4	364588.58	4888397.36	178.68	0	500	99.4	99.4	0.0	0.0	79.7	5.3	-0.9	0.0	0.0	0.0	0.0	-0.0	15.3	15.3
5	364588.58	4888397.36	178.68	0	1000	100.3	100.3	0.0	0.0	79.7	10.0	-0.9	0.0	0.0	0.0	0.0	-0.0	11.5	11.5
6	364588.58	4888397.36	178.68	0	2000	95.9	95.9	0.0	0.0	79.7	26.4	-0.9	0.0	0.0	0.0	0.0	-0.0	-9.3	-9.3
7	364588.58	4888397.36	178.68	0	4000	86.1	86.1	0.0	0.0	79.7	89.5	-0.9	0.0	0.0	0.0	0.0	-0.0	-82.3	-82.3
8	364588.58	4888397.36	178.68	0	8000	68.1	68.1	0.0	0.0	79.7	319.3	-0.9	0.0	0.0	0.0	0.0	-0.0	-330.0	-330.0

Point Source, ISO 9613, Name: "(untitled)", ID: "S37"																			
Nr.	X	Y	Z	Refl.	Freq.	LxT	LxN	K0	Dc	Adiv	Aatm	Agr	Afol	Ahous	Abar	Cmet	RL	LrT	LrN
	(m)	(m)	(m)		(Hz)	dB(A)	dB(A)	(dB)	(dB)	(dB)	(dB)	(dB)	(dB)	(dB)	(dB)	(dB)	(dB)	dB(A)	dB(A)
1	365500.96	4889854.04	185.85	0	63	84.6	84.6	0.0	0.0	83.7	0.5	-3.8	0.0	0.0	0.0	0.0	-0.0	4.2	4.2
2	365500.96	4889854.04	185.85	0	125	92.4	92.4	0.0	0.0	83.7	1.8	1.5	0.0	0.0	0.0	0.0	-0.0	5.4	5.4
3	365500.96	4889854.04	185.85	0	250	97.6	97.6	0.0	0.0	83.7	4.5	-0.2	0.0	0.0	0.0	0.0	-0.0	9.6	9.6
4	365500.96	4889854.04	185.85	0	500	99.4	99.4	0.0	0.0	83.7	8.3	-1.2	0.0	0.0	0.0	0.0	-0.0	8.5	8.5
5	365500.96	4889854.04	185.85	0	1000	100.3	100.3	0.0	0.0	83.7	15.8	-1.2	0.0	0.0	0.0	0.0	-0.0	2.0	2.0
6	365500.96	4889854.04	185.85	0	2000	95.9	95.9	0.0	0.0	83.7	41.7	-1.2	0.0	0.0	0.0	0.0	-0.0	-28.4	-28.4

Point Source, ISO 9613, Name: "(untitled)", ID: "S37"

Nr.	X	Y	Z	Refl.	Freq.	LxT	LxN	K0	Dc	Adiv	Aatm	Agr	Afol	Ahous	Abar	Cmet	RL	LrT	LrN
	(m)	(m)	(m)		(Hz)	dB(A)	dB(A)	(dB)	(dB)	(dB)	(dB)	(dB)	(dB)	(dB)	(dB)	(dB)	(dB)	dB(A)	dB(A)
7	365500.96	4889854.04	185.85	0	4000	86.1	86.1	0.0	0.0	83.7	141.4	-1.2	0.0	0.0	0.0	0.0	-0.0	-137.9	-137.9
8	365500.96	4889854.04	185.85	0	8000	68.1	68.1	0.0	0.0	83.7	504.5	-1.2	0.0	0.0	0.0	0.0	-0.0	-518.9	-518.9

Suite 500, 4342 Queen Street  
Niagara Falls, Ontario, Canada L2E 7J7  
Tel 905 374 5200 ♦ Fax 905 374 1157



Suite 500, 4342 Queen Street  
Niagara Falls, Ontario, Canada L2E 7J7  
Tel 905 374 5200 ♦ Fax 905 374 1157